

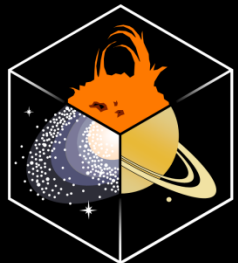

„The e-Callisto network“



Solar Radio Astronomy,
Space Weather, Education,
Radio monitoring



ETH Zurich
Institute of
Astronomy

Christian Monstein
Institute for Astronomy
ETH Zürich
Switzerland





Topics

- General information about project and instrument
- Coverage aspects
- Presentation of some (not all) observation sites
- Network structure
- Science aspects
- Conclusions



Callisto as Swiss - contribution to IHY2007 and ISWI

C ompound
A stronomical
L ow cost
L ow frequency
I nstrument for
S pectroscopy and
T ransportable
O bservatory

10th anniversary of Callisto since 1st light of the prototype receiver in 2002



What is Callisto good for?

- Real-time observation of dynamic, electromagnetic solar radio bursts.
- Radio-monitoring, environmental studies, site evaluation for other radio-telescopes.
- Animal tracking system (e.g. baboon tracking in SA)
- Tourist guide tracking system (Nepal, Himalaya)
- Education & outreach
- Electronics training for physics apprentices



Specification Callisto

Parameter

Specification

Frequency range	45.0 MHz ... 870.0 MHz ($34 \text{ cm} < \lambda < 6.7 \text{ m}$) any other range, using heterodyne/homodyne converters
Frequency resolution	62.5 KHz (13'200 channels)
Radiometric bandwidth	300 KHz @ -3dB
Integration time	1 msec
Dynamic range	> 50 dB
Detector sensitivity	25.4 mV/dB
Noise figure	< 10 dB
Measuring rate	800 pixels/sec maximum
Sweep length	1...400, nominal 200 frequencies per sweep
Power consumption	12 V +/- 2 V / ~225 mA (2.7 Watt)
Weight	~ 1 kg
Dimensions	110 mm x 80 mm x 205 mm
Cost	Hardware < 500\$, labour 1 week (soldering, testing etc.)
Inputs	4 files (configuration, frequency, scheduler, calibration)
Outputs	4 files (FITS-files, logfile, light curve file, spectral overview)

Schematics Callisto

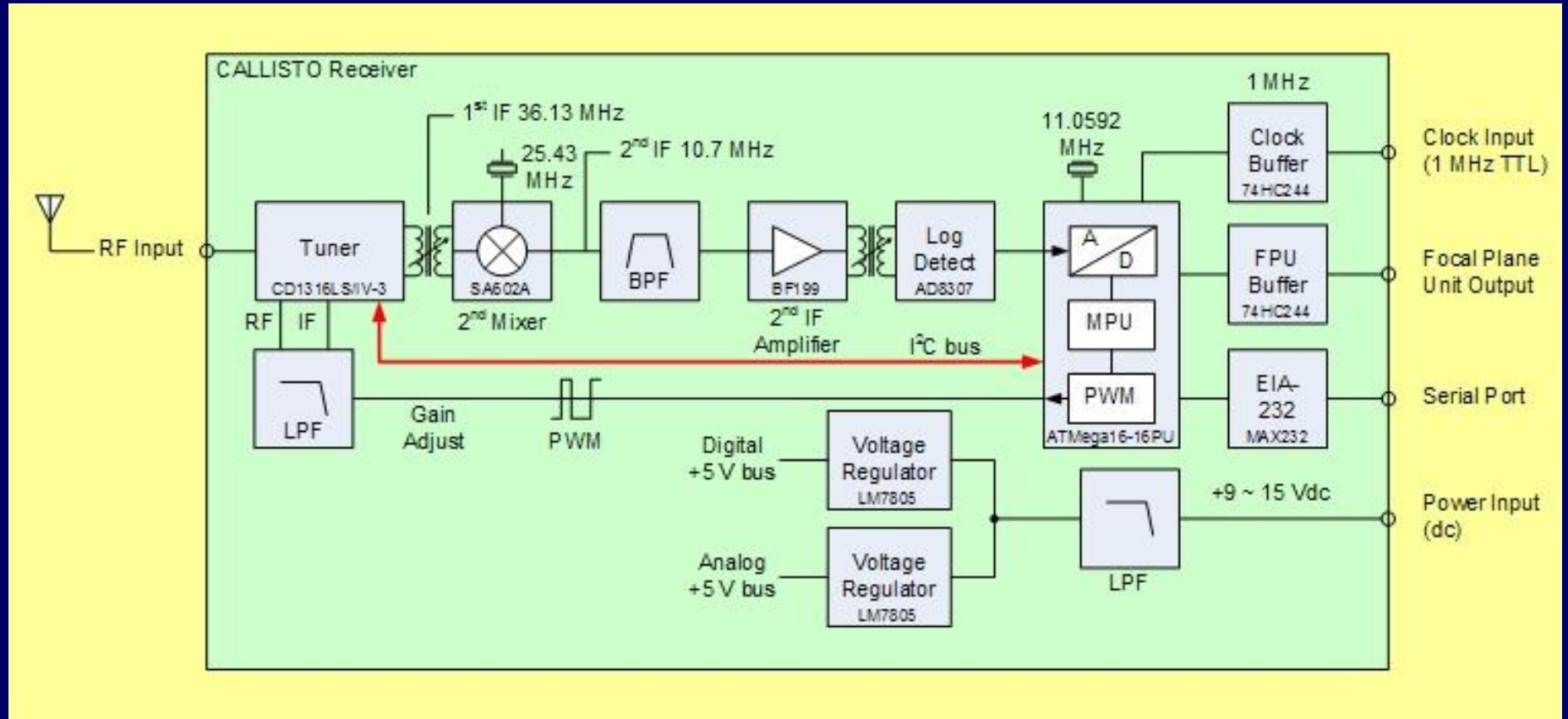

24h/7day of observation

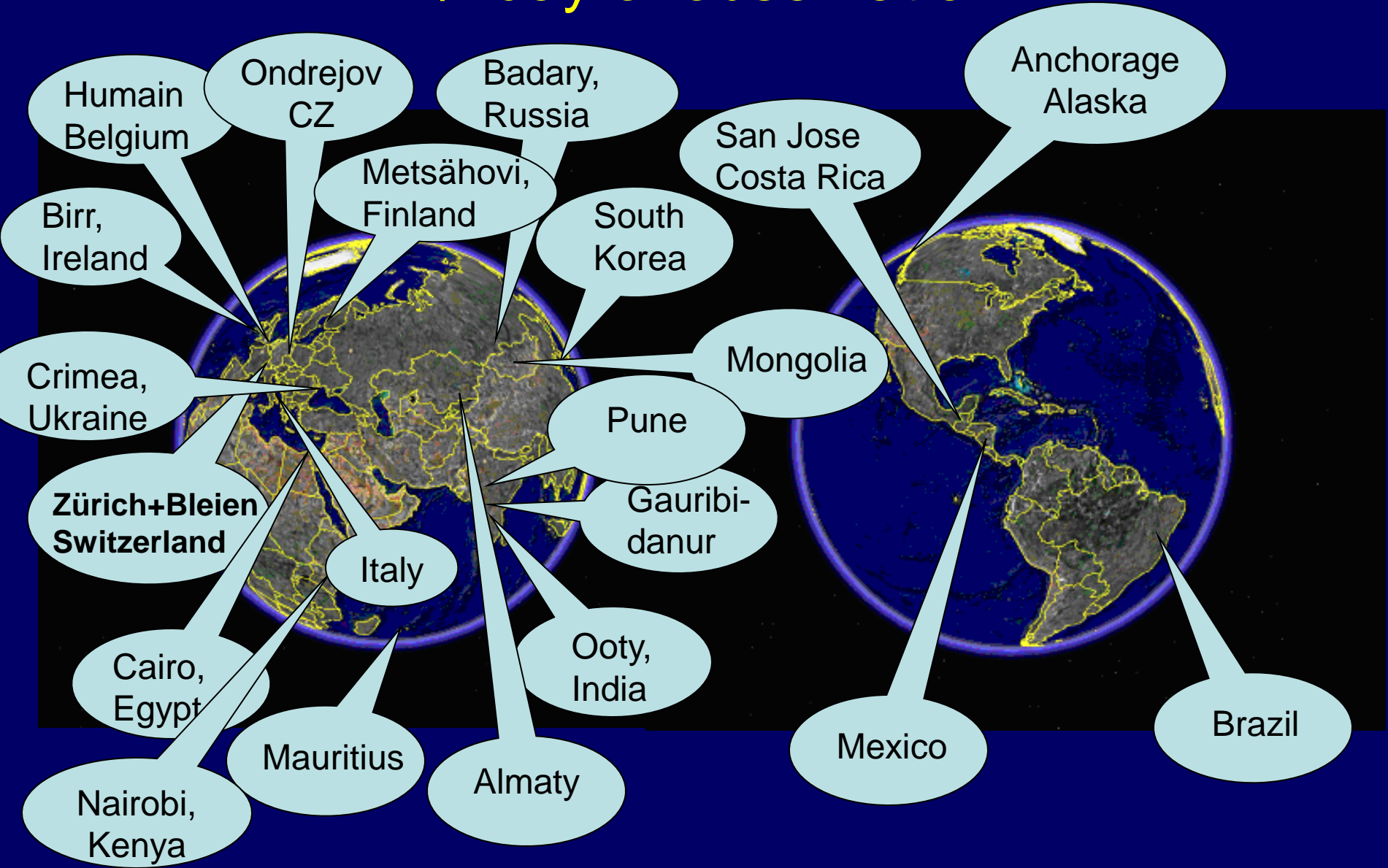

Coverage

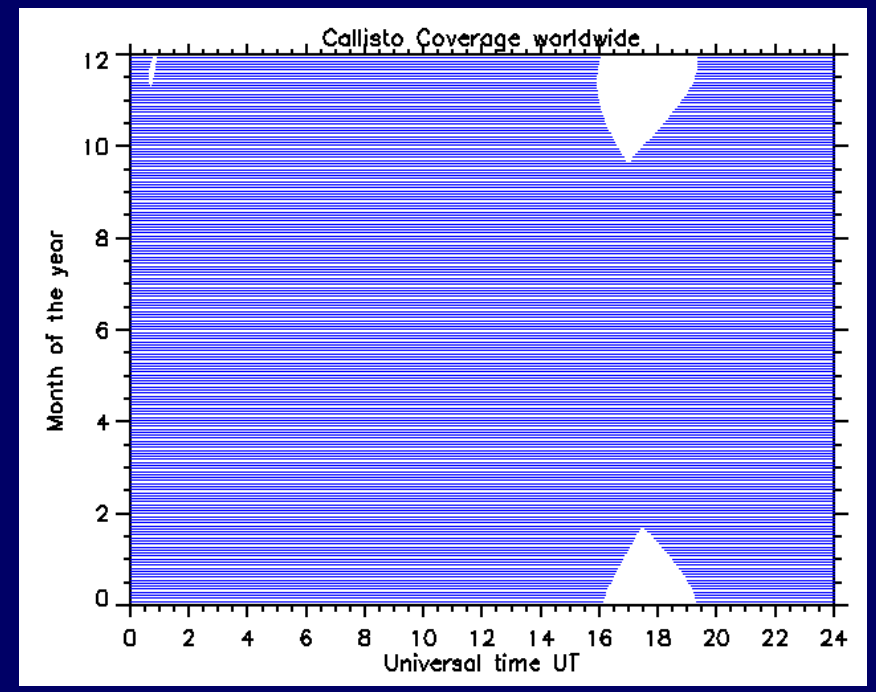
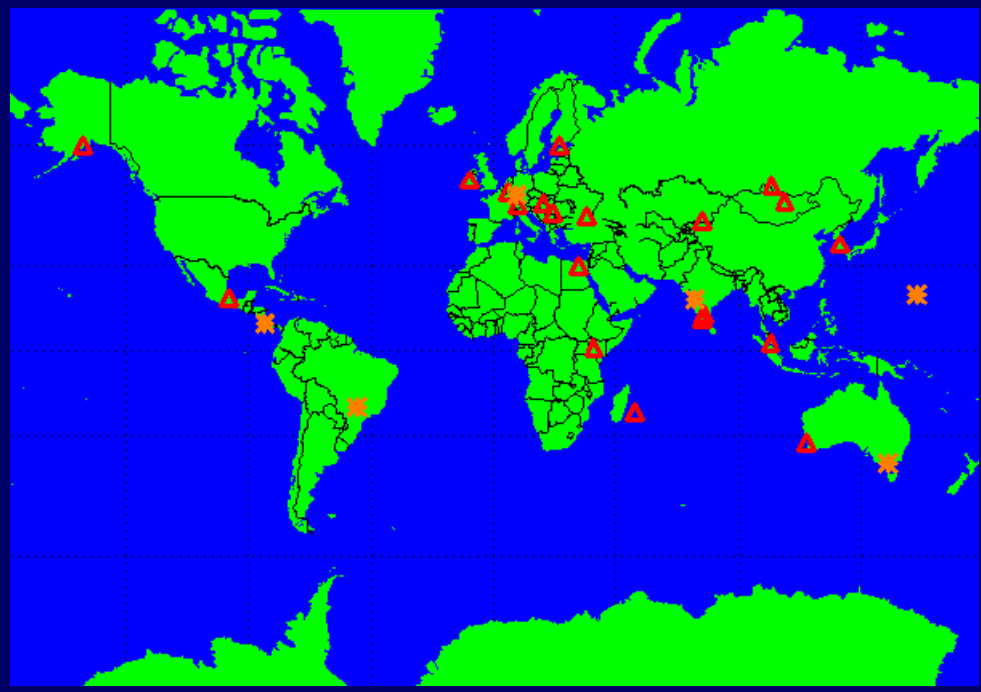

Geographical distribution

FoV: 24h/365d

Status Sep. 2012: 48 instruments at 32 different locations worldwide

Coverage Bandung

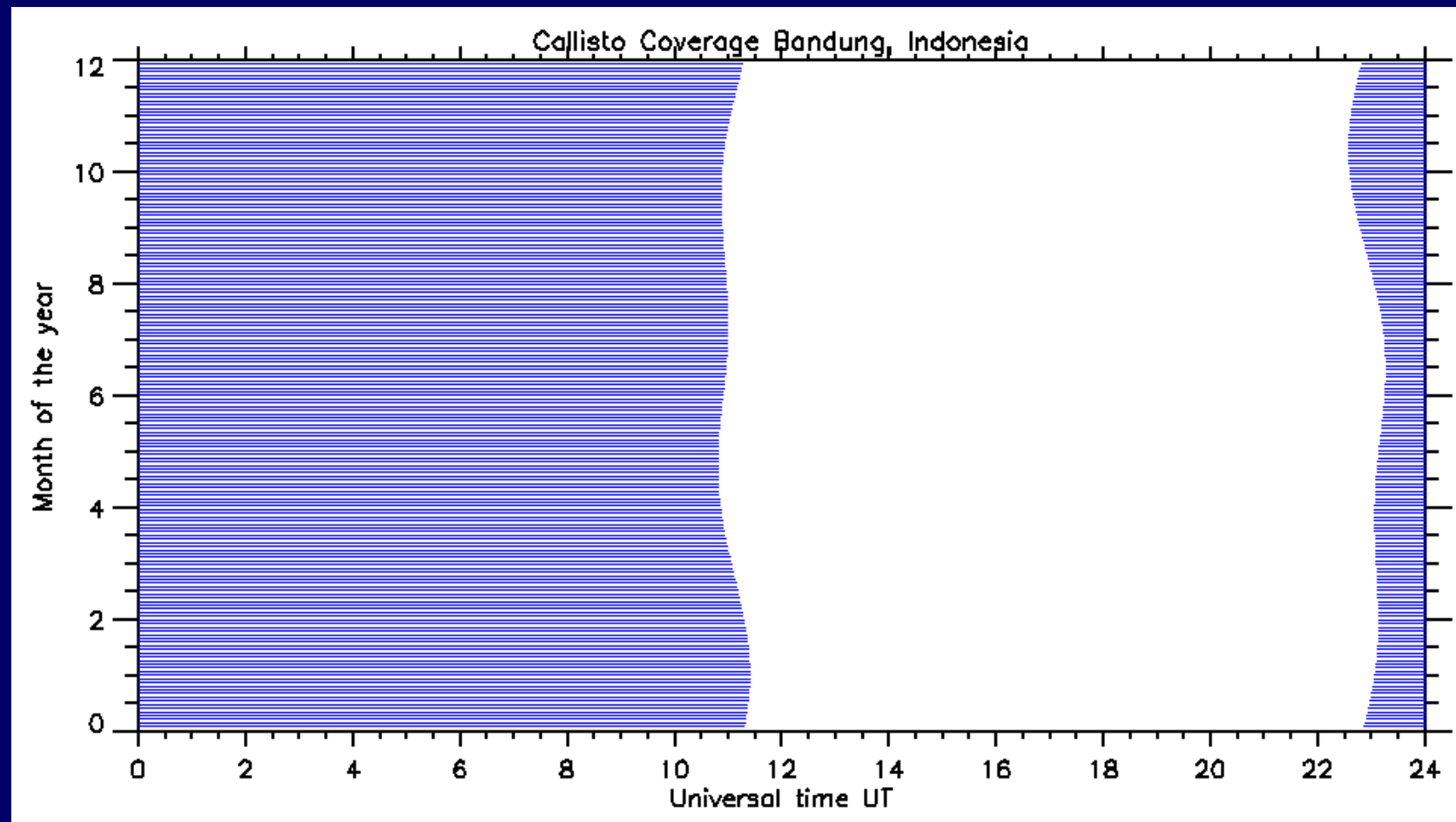

FoV: 12h/365d

Interference situation

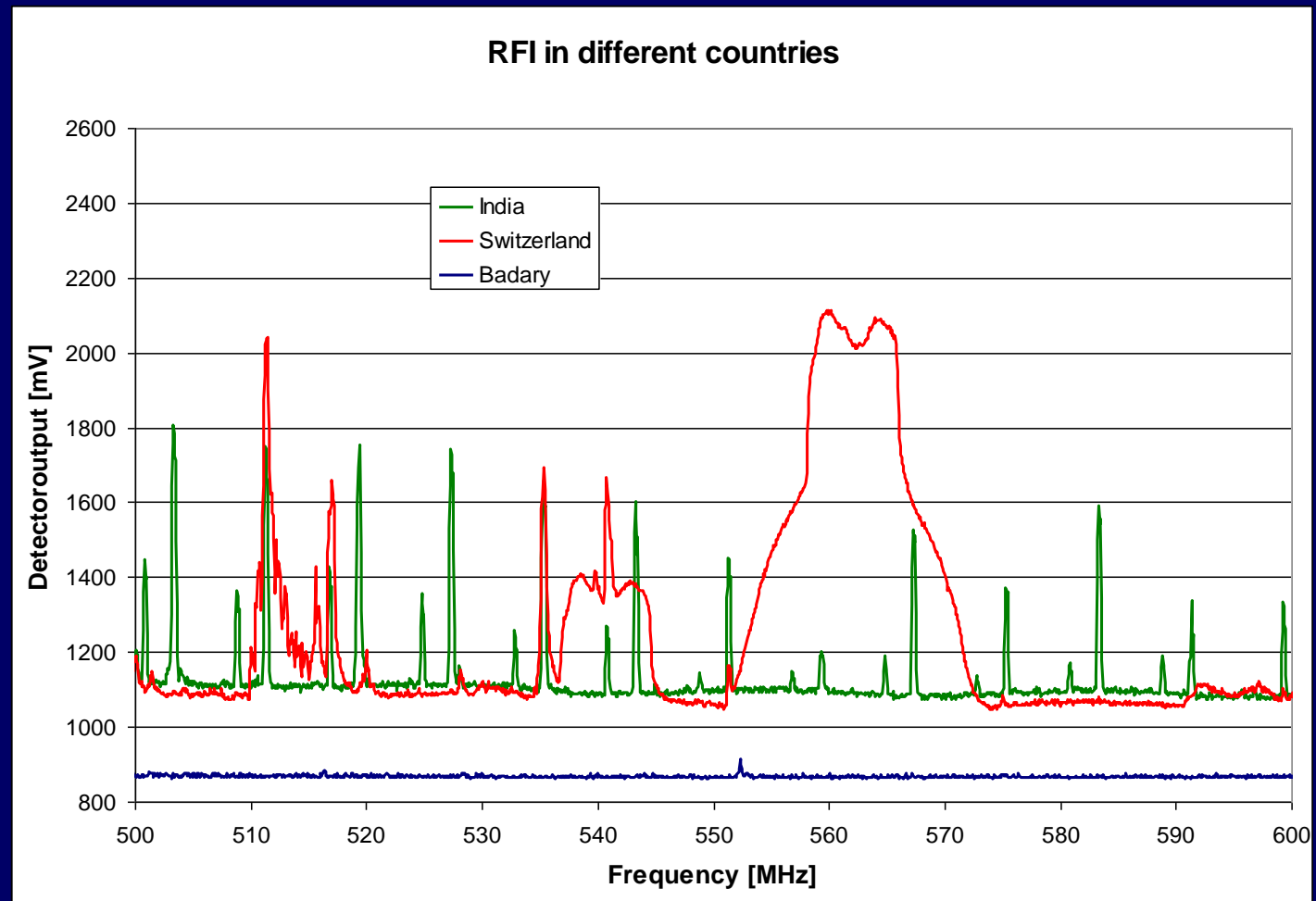

Radio frequency interference Switzerland compared to India and Russia in 2006

Callisto prototype at ETH Zurich, Switzerland



Antenna at sun tower
of Zurich observatory
pointing to the sun

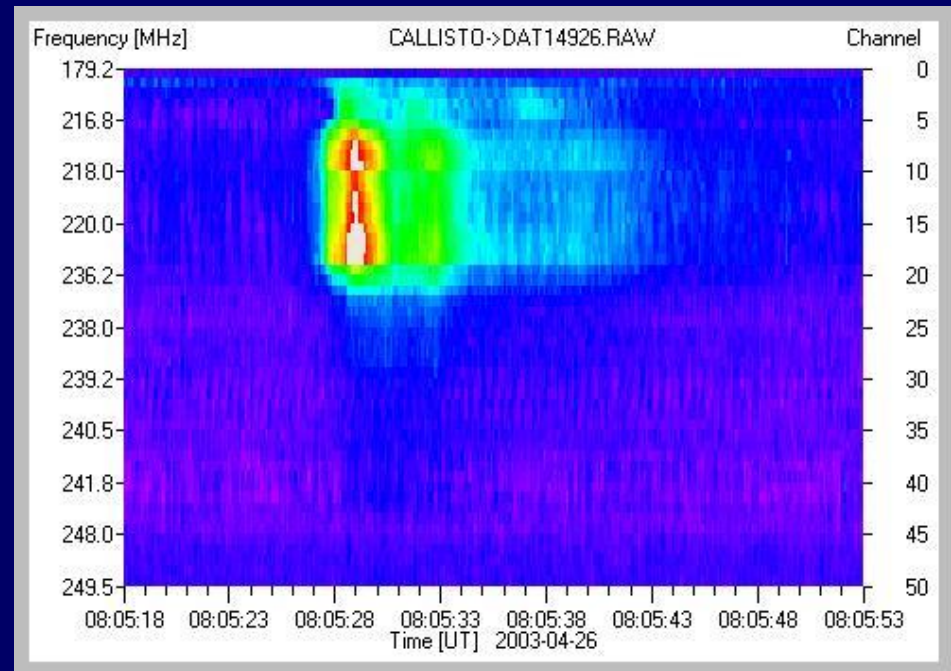

Dynamic spectrum
captured by Callisto
on 26th of April 2003

Callisto at TIFR in Ootacamund, India



Left: Self built antenna.

Right: Operator at the Institute of
Radio astronomy and Nuclear Physics,
Tamil Nadu in Ooty India 2006

Callisto at TIFR in Ootacamund, India

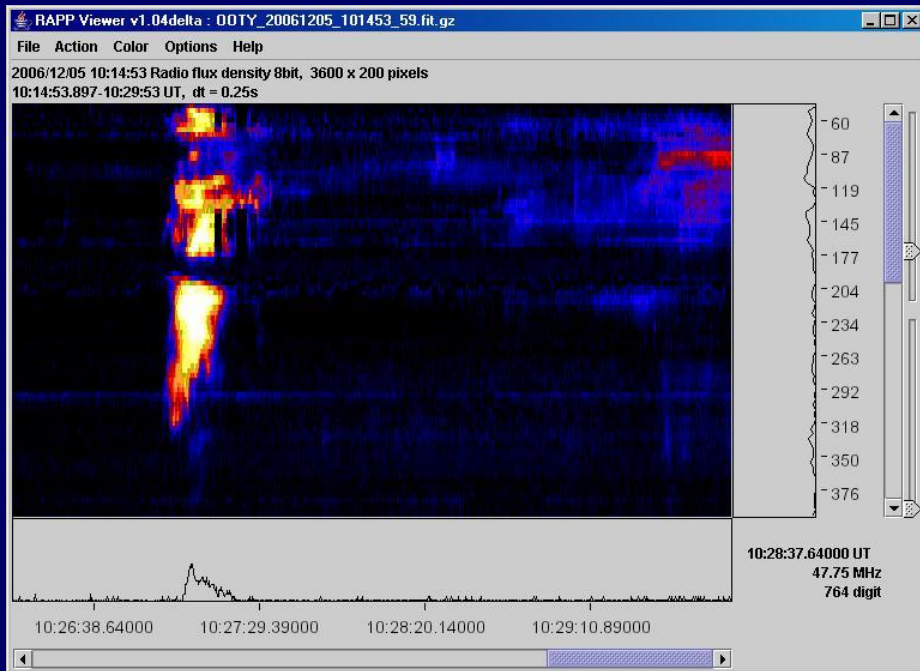

Astronomical outcome, first light

Gastronomic highlight

Callisto at IIA in Gauribidanur, India



Left: Self built antenna.

Right V. C. Kathirvaran at
Indian Institute of Astrophysics
Gauribidanur / Bangalore 2006

Callisto at IIA in Gauribidanur, India

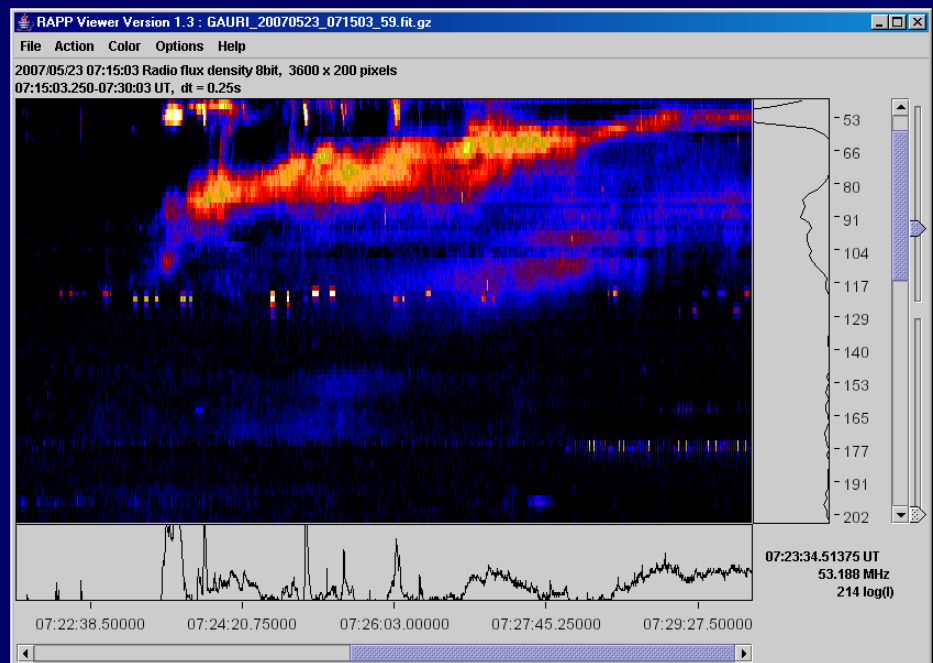

Astronomical outcome, first light.
A type II flare with herringbone
structures and harmonics

Gastronomic highlight

Callisto at Institute of Solar-Terrestrial Physics (ISTP) in Badary / Siberia, Russian Federation



5 GHz antenna farm
of SSRT in Siberia



Antenna attached to dish



Sergey and Andrey at SSRT

Callisto at Institute of Solar-Terrestrial Physics (ISTP) in Badary / Siberia, Russian Federation

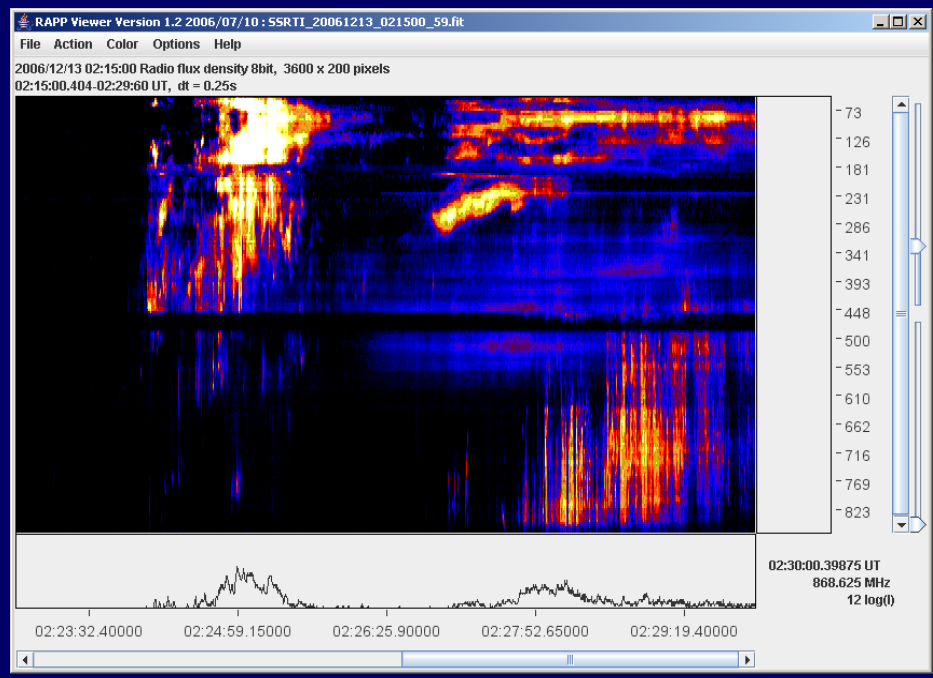

Astronomical outcome, first light.
Different burst types within 15 minutes

Gastronomic non-highlight

Callisto at KASI in Daejeon, South Korea



Antenna tower of Solar and Space Weather Group of Korea Astronomy and Space Science Institute (KASI)



Phd Student Hee-Sun reproducing a Callisto-spectrometer as a semester work in physics 2007.

Callisto at KASI in Daejeon, South Korea

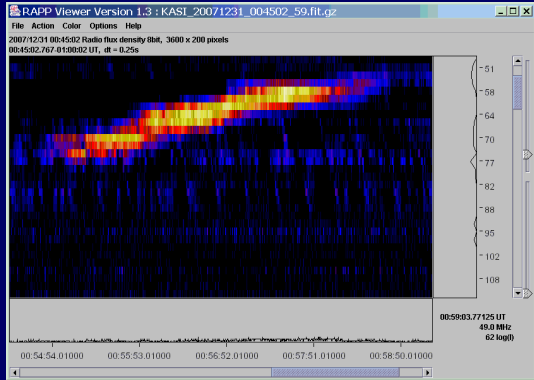

Slow drift burst ↑
connected
to a CME ↓

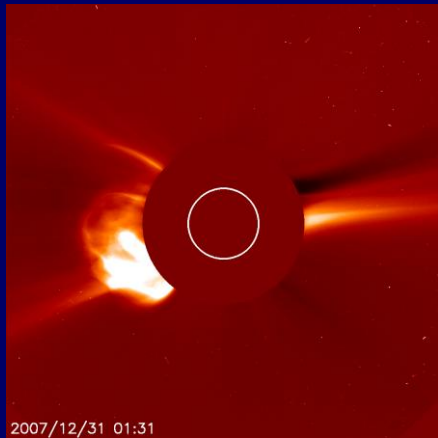

Just one of the
gastronomic
highlights

Callisto at ROB in Humain, Belgium

ROB (Royal Observatory of Belgium)



Broad band log-per
attached to a 4 m dish

Hmm,
where is this strong interference coming from.....?

Callisto at ROB in Humain, Belgium

ROB (Royal Observatory of Belgium)

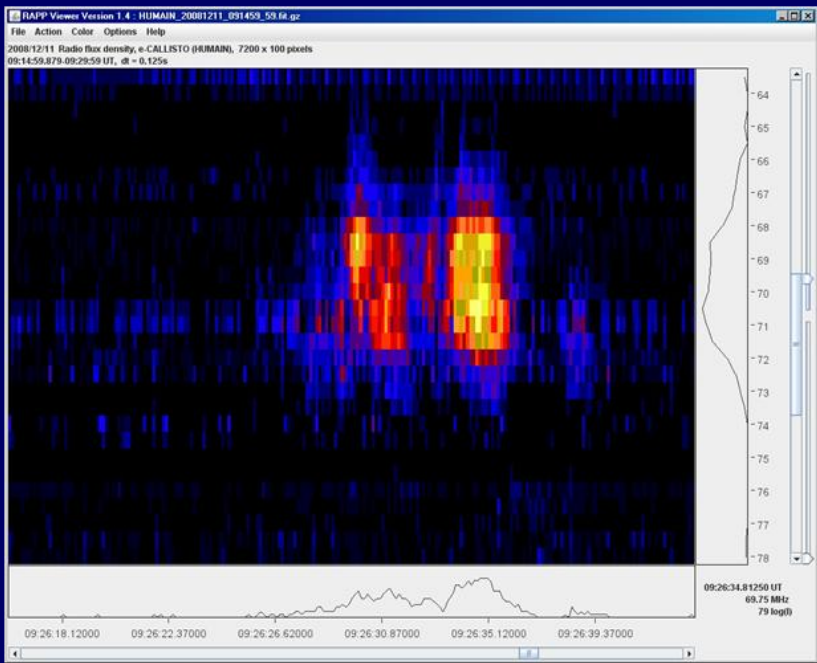

Astronomical outcome, first light
on December 11th 2008

Gastronomic result...

Callisto in Bras d'Eau Flacq, University of Mauritius

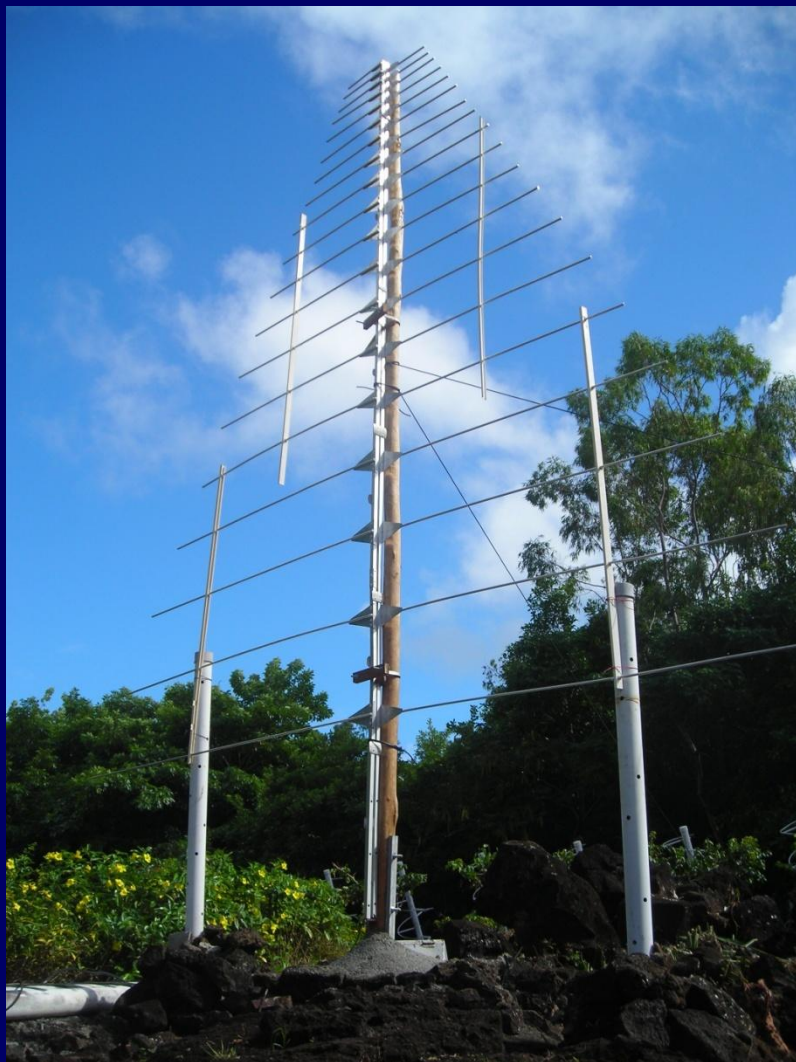

Self built log-per 20 MHz ... 150 MHz and

Callisto in air-conditioned receiver room
in Bras d'Eau, Poste de Flacq, Mauritius



Callisto in Bras d'Eau Flacq, University of Mauritius

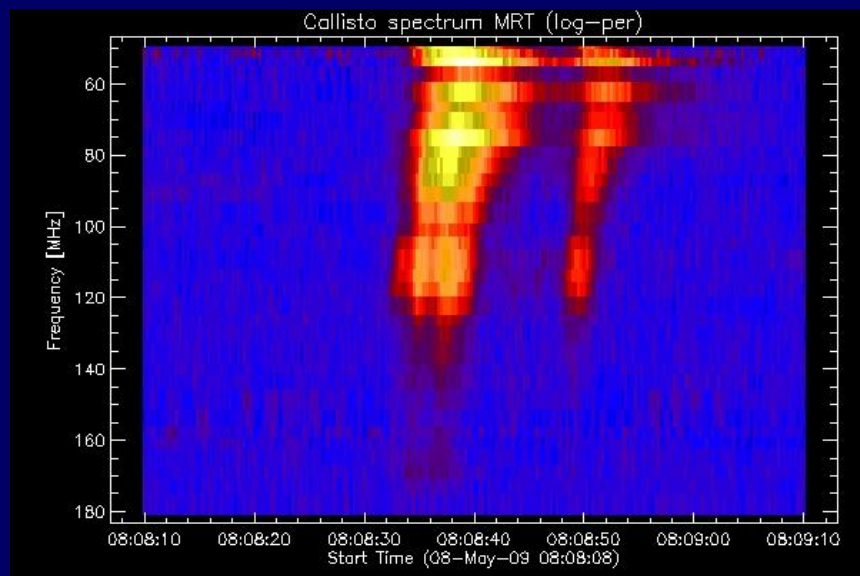

Astronomical outcome, first light
on May 1st 2009 08:08:30 UT.
Two fast drifting bursts.

Gastronomic result ...

Callisto at RCAG in Ulaan Baatar, Mongolia



Munkhbayar Bazargur
and his colleague mounting
a Chinese DVB-T - antenna



Callisto and PC in the office of the RCAG
(Research Center of Astronomy and Geophysics)
located at the observatory site at Khurel Togoot
near Ulaan Baatar, Mongolia

Callisto at RCAG in Ulaan Baatar, Mongolia

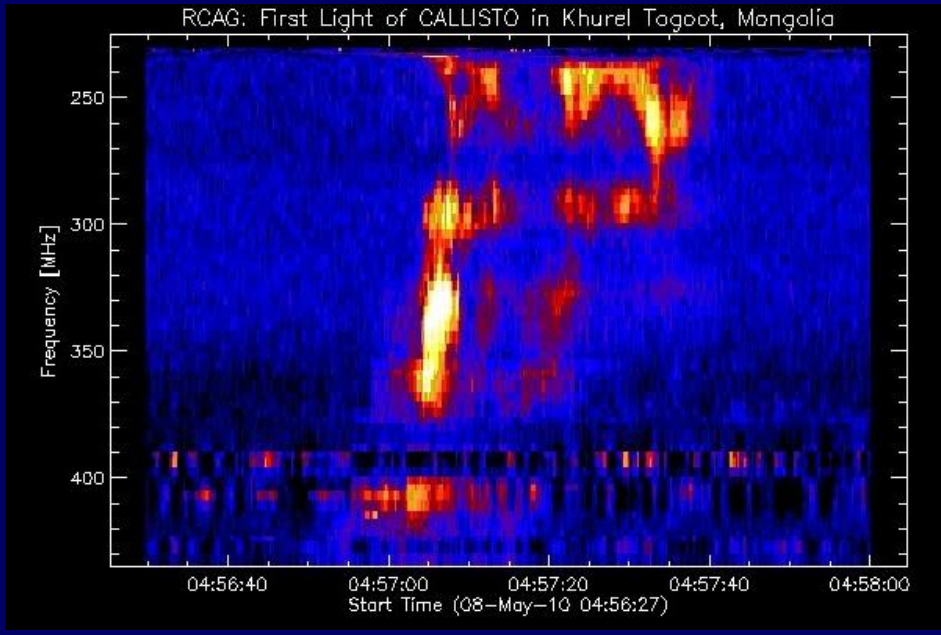

First light in May 2010
from Khurel Togoot,
Ulaan Baatar, Mongolia

Gastronomic highlight ...
to be flushed with a lot
of Beer and Vodka...

Callisto Trinity College Dublin, Ireland



Birr castle (950 AD) with Lord William
Brendan Parsons, 7. Earl of Rosse



Leviathan of Parsonstown is the unofficial name of the Rosse six foot telescope. The largest telescope in the world from 1845 until the construction of the 2.5 m Hooker Telescope in 1917. (Detection of M51)



EGIS rotator and LPDA



Ex sheep shed

Callisto Trinity College Dublin, Ireland

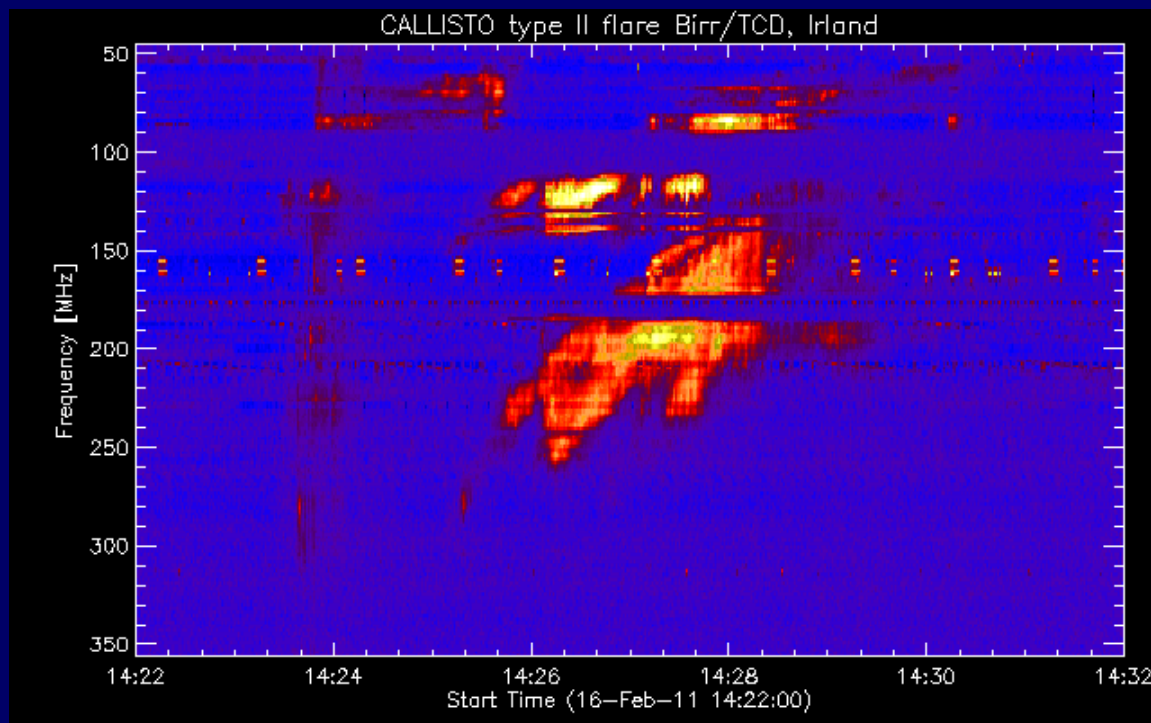

**Gastronomic result
dining hall at TCD in
Dublin.**

**Astronomical result:
Recent slow drifting type II flare
with harmonics and band splitting**



Callisto in Ondřejov, Astronomical Institute of the Academy of Sciences of the Czech Republic

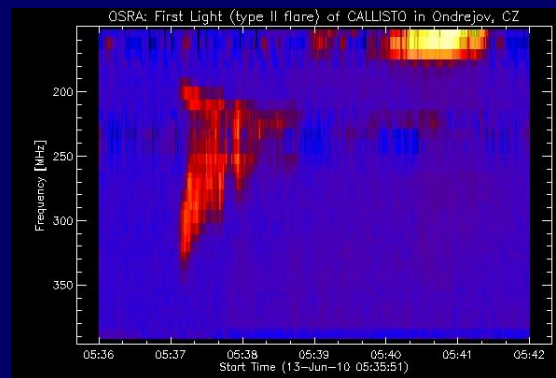

“Würzburg Riese”, original 7m dish of
2nd WW. 150 MHz – 870 MHz linear,
horizontal polarization.



First light:
High frequency
part of a type II burst.

← Gastronomic highlight

Callisto in Metsähovi, University of Helsinki, Finland



**DVB-T log-per
attached to a
37 GHz
microwave-dish**

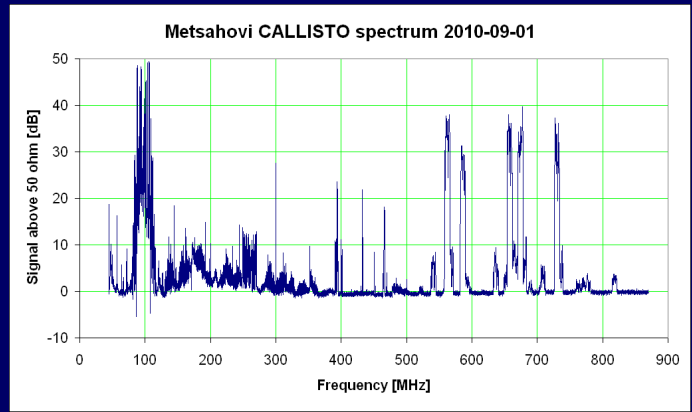

- Spectral overview shows:**
- FM,
 - Military satellites
 - Schengen-Police-comm.
 - many DVB-T

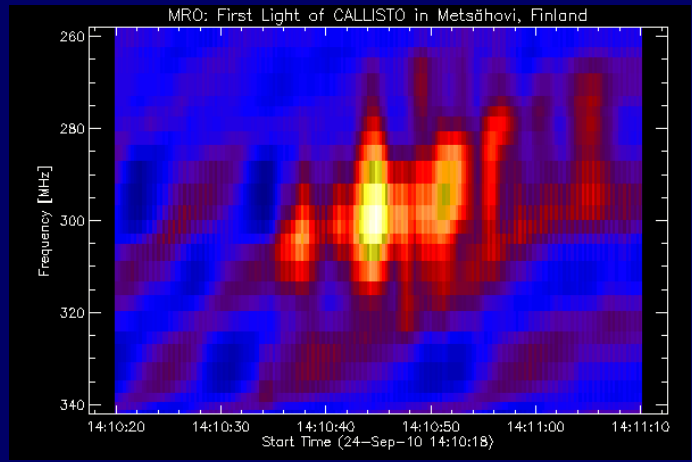

**First light at MRO,
part of a solar noise storm**



Finlands gastronomy

Callisto at Institute of Ionosphere Almaty, Kazakhstan



Log-per antenna mounted at the lower rim of the 12m dish of a Russian satellite tracking Antenna at Tian Shan mountains 3000 m asl.



Standard Windows PC controlling Callisto and the FTP client.
Oleg Gontarev, Institute of Ionosphere
Kamenskoie Plato, Almaty, Kazakhstan

Callisto in Almaty, Kazakhstan

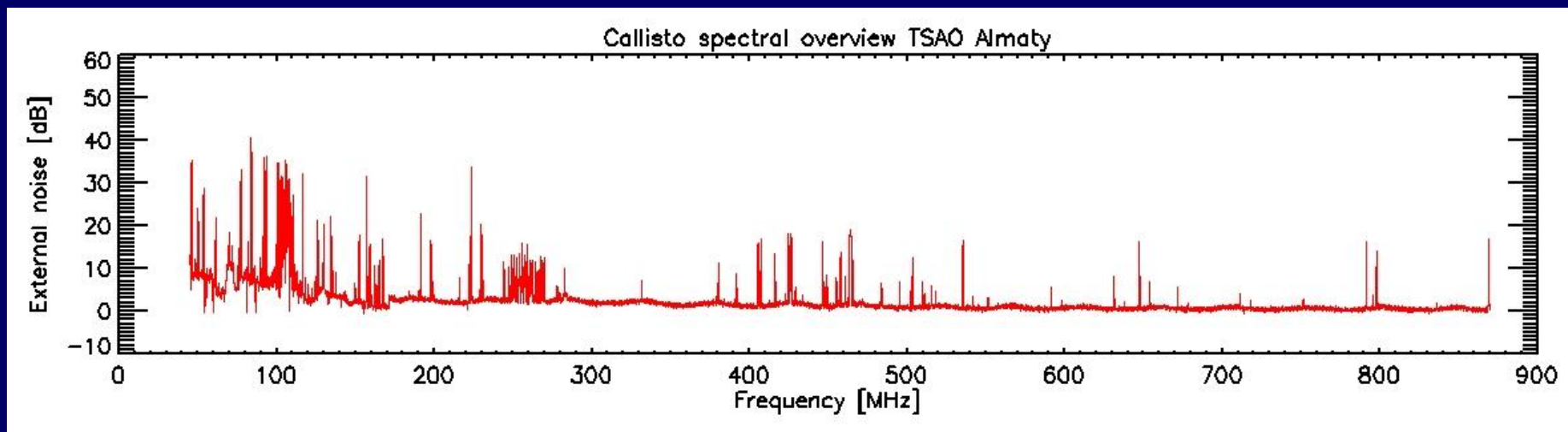

Spectral overview (top), 1st light (bottom left), Gastronomy (bottom right)

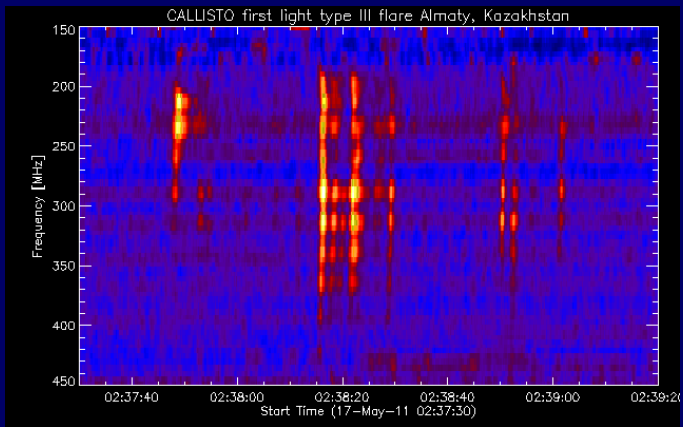

1st light small group of type III

Gastronomic highlights: Vodka and Plov

Callisto at Helwan University Cairo, Egypt

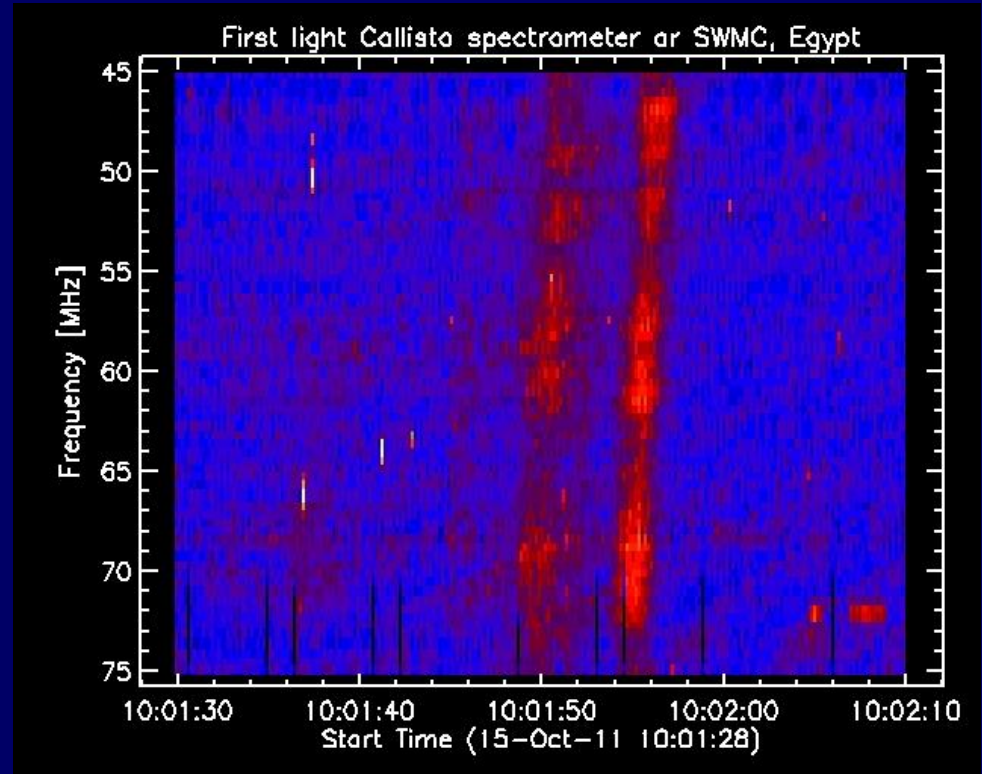

Left: Log-per 6m wide and 6m high 20 MHz – 175 MHz on the roof of SWMC.
Right: 1st light two fast drifting type III bursts

Callisto at Pune University, India

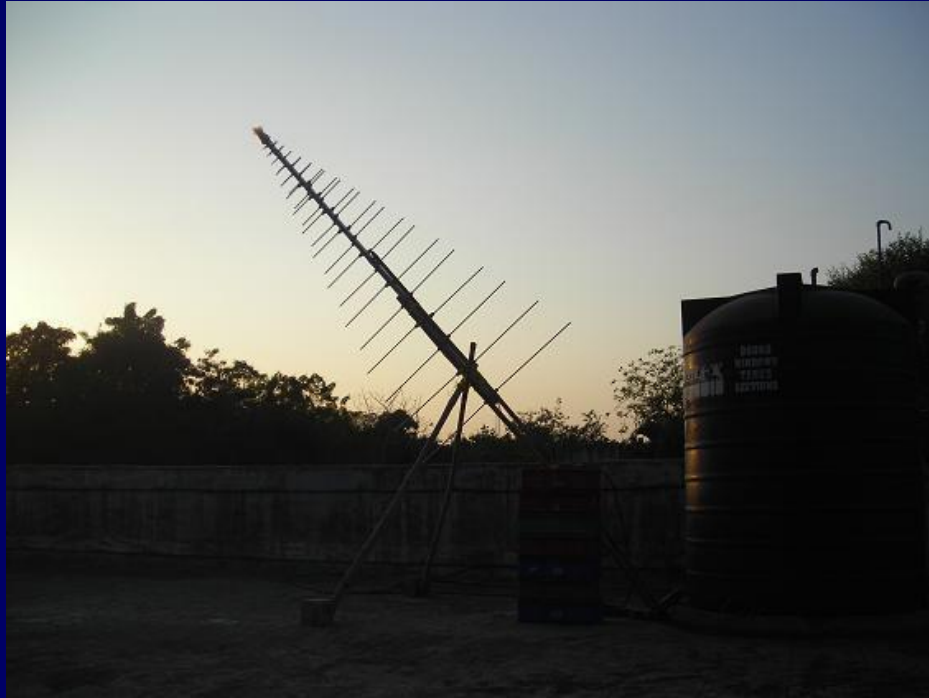

Indian design of log-per 100 MHz-1000MHz



Observatory room with Callisto

Callisto at Pune University, India

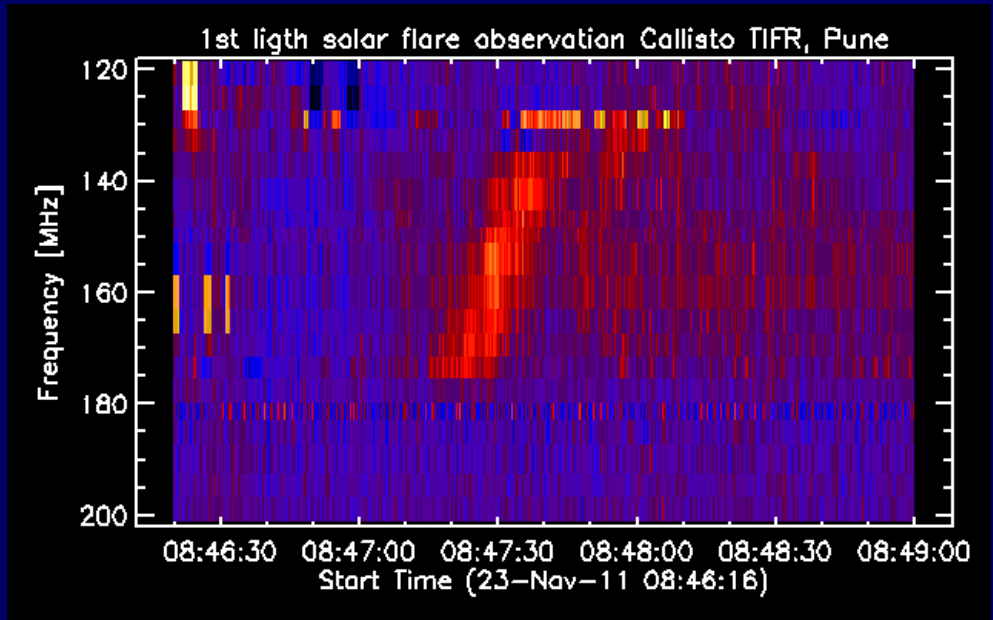

Left: 1st light a weak type II burst

Gastronomic highlight at Pune University

Callisto at University of Nairobi, Kenya



Francis Juma Omollo, Kenneth Kaduki, Geoffrey O’Kengo,
John Buers, Paul Baki and Hyder Karimi N’Goki



Callisto at National Space Agency Kuala Lumpur, Malaysia

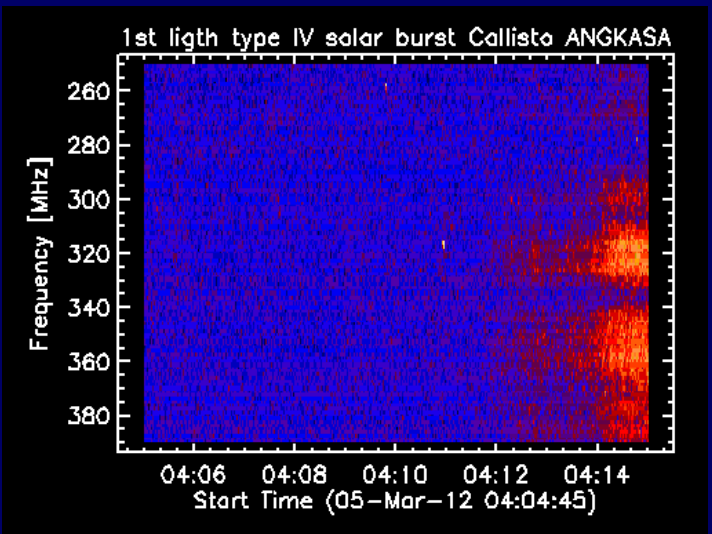

Callisto at National Space Agency Kuala Lumpur, Malaysia



e-Callisto network

<http://soleil.i4ds.ch/solarradio/>

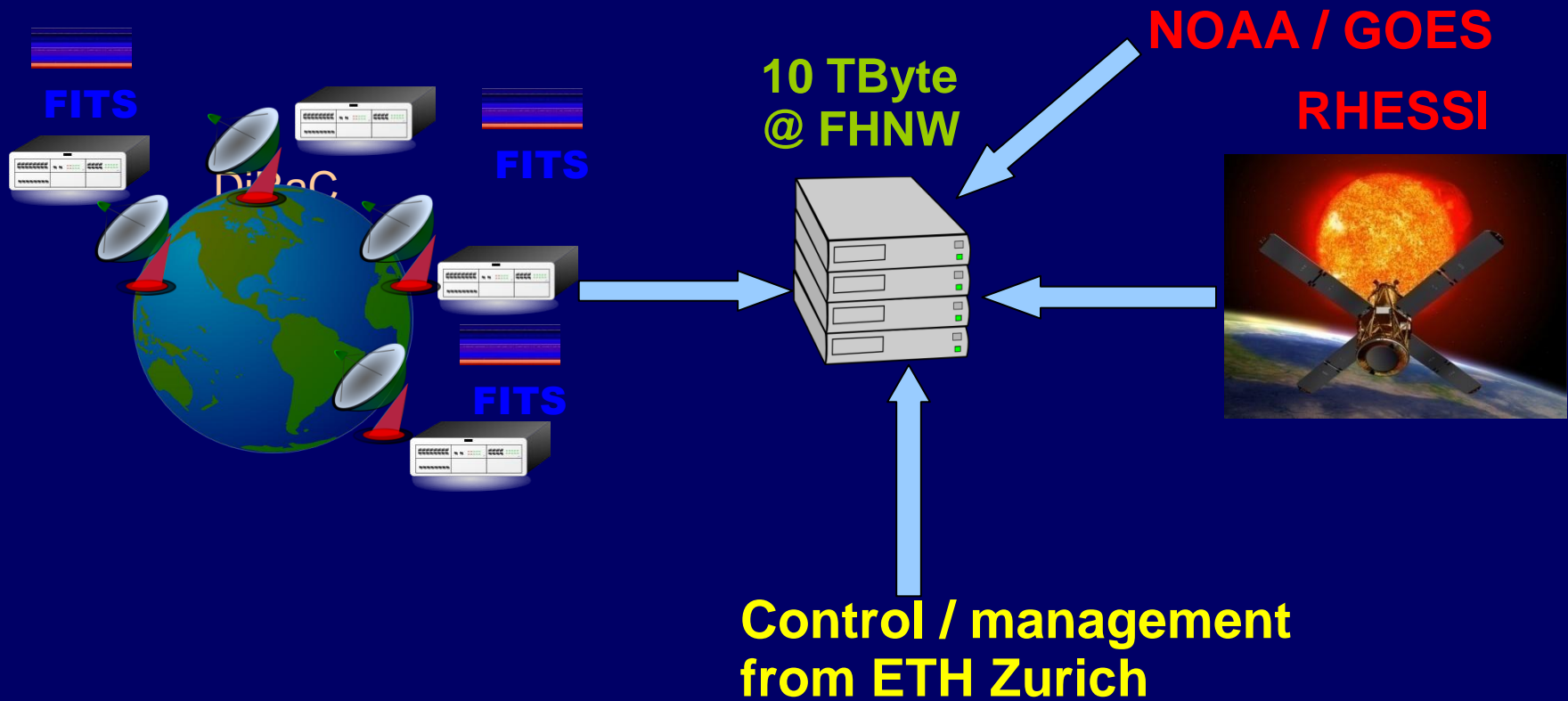

Current User Statistics



~ 500 worldwide visits per month from > 60 countries

~ 60 GByte solar radio data per year (FITS-files)

10 Tera Byte data archive available at FHNW (André Csillaghy)

Geographical Redundancy

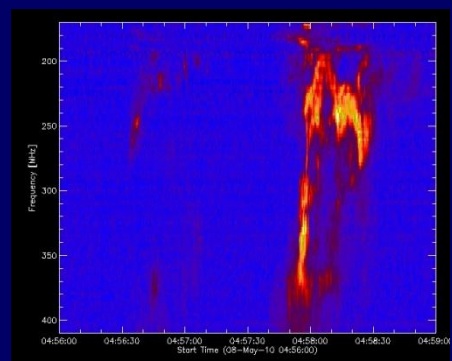
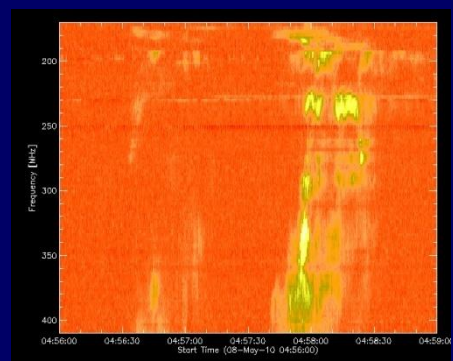
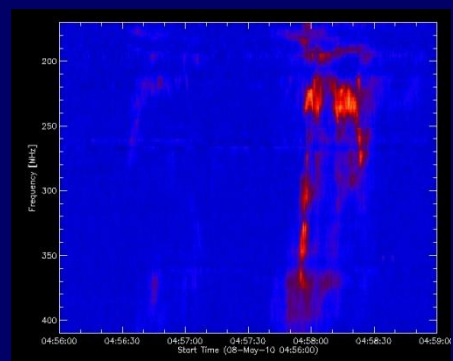
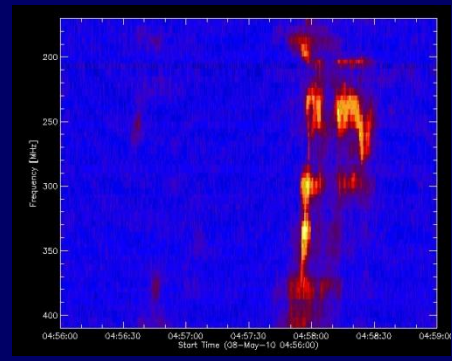
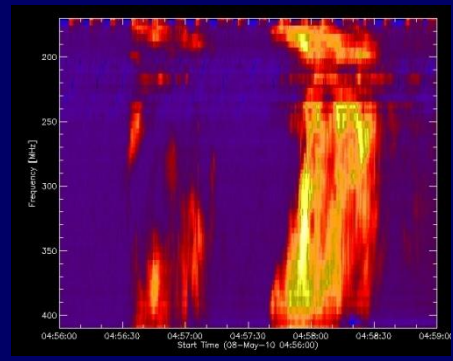
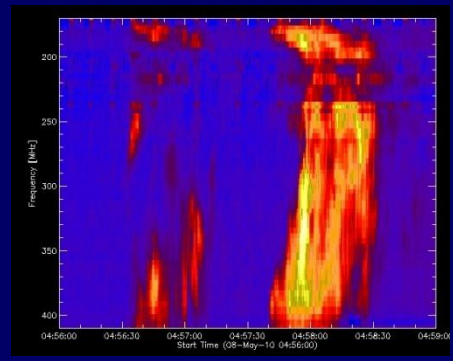

2 x Bleien (LHCP, RHCP) + Mauritius + Ooty + Gauribidanur + Siberia
Event of May 8th 2010 at 04:56 - 04:59 UT

6 integrated locations

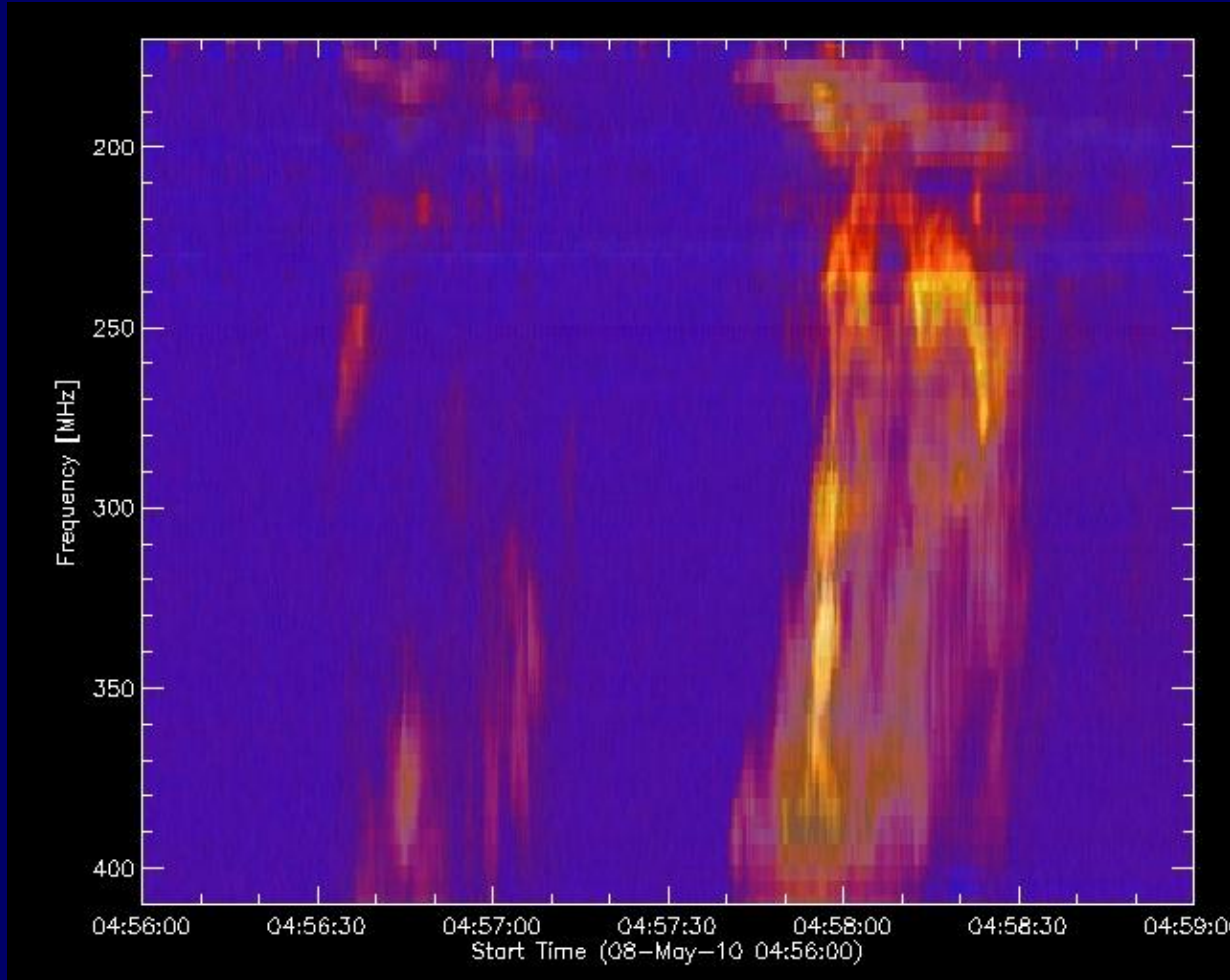

6 different locations integrated into one plot improves SNR by $6 \cdot \sqrt{6} = 11.7$ dB
Radio frequency interference goes down with a factor of 6 per location = -7.8 dB

Append in frequency range

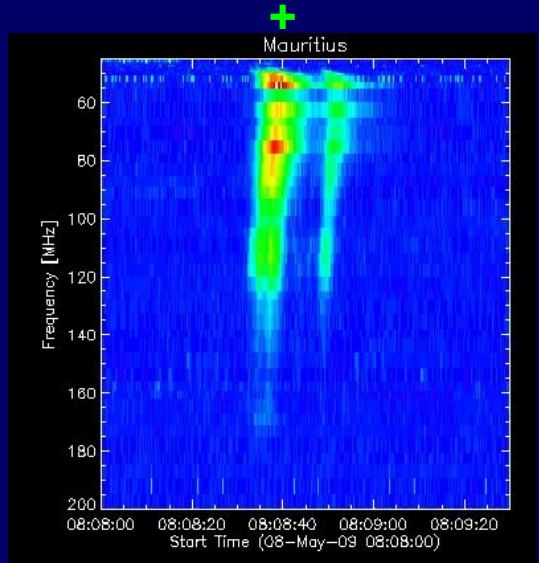
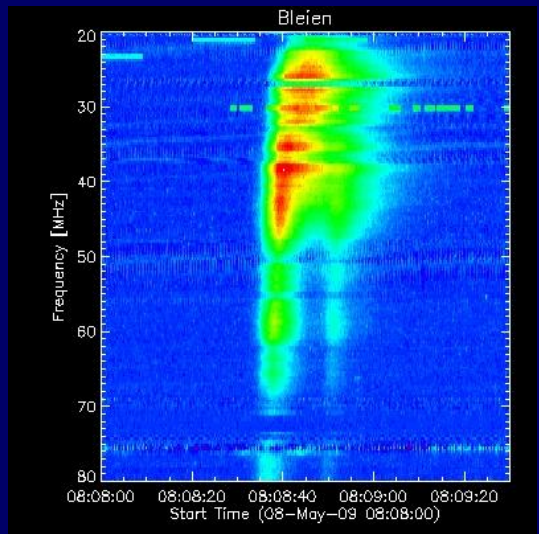

+

=

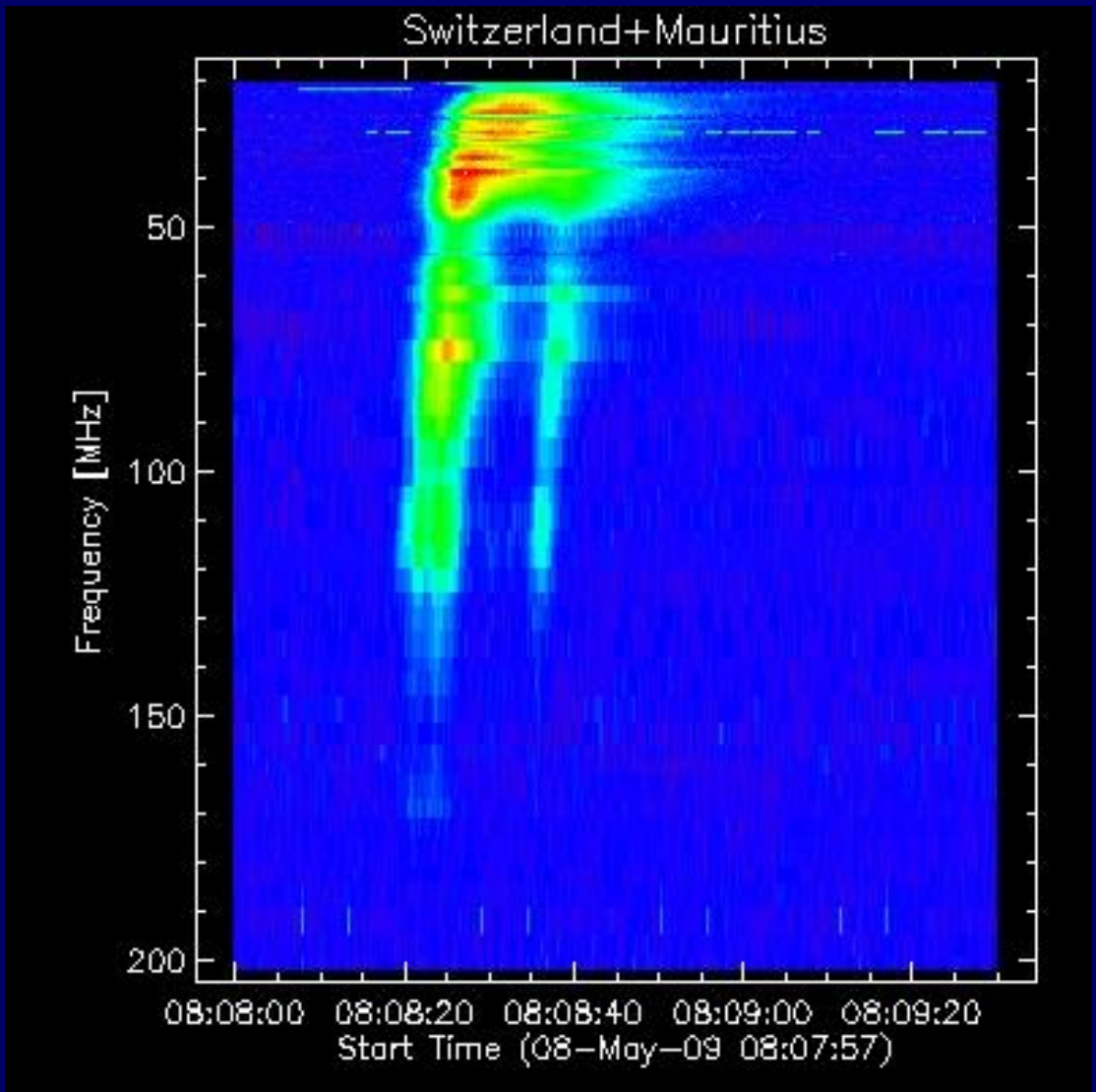

Bleien 20-60 MHz + Mauritius 63-200 MHz, event of 2009-May-08 08:08 UT



Publications

13 reviewed and published papers over a period of ~8 years

Arnold O. Benz, Christian Monstein, Hansueli Meyer ETH Zurich, *Solar Physics*, 226, 143 - 151 (2004)

Benz, A. O.; Perret, H.; Saint-Hilaire, P.; Zlobec, P. *Advances in Space Research*, Volume 38, Issue 5, p. 951-955. (2005)

Pick, Monique; Malherbe, Jean-Marie; Kerdraon, Alain; Maia, Dalmiro Jorge Filipe
The Astrophysical Journal, Volume 631, Issue 1, pp. L97-L100. (2005)

Monstein, C.; Ramesh, R.; Kathiravan, C. *Bulletin of the Astronomical Society of India*, Vol. 35, p. 473-480 (2007)

Benz, A. O.; Monstein, C.; Meyer, H.; Manoharan, P. K.; Ramesh, R.; Altyntsev, A.; Lara, A.; Paez, J.; Cho, K.-S.
Earth, Moon, and Planets, Volume 104, Issue 1-4, pp. 277-285 (2008)

Monstein, Ch. A.; Lesovoy, S. V.; Maslov, A. I. *Geomagnetism and Aeronomy*, Volume 49, Issue 7, pp.856-859 (2009)

Bong, S.-C., Kim, Y.-H., Roh, H., Cho, K.-S., Park, Y.-D., Choi, S., ,
Journal of the Korean Astronomical Society, vol. 42, no. 1, pp. 1-7 (2009)

Ramesh, R.; Kathiravan, C.; Barve, Indrajit V.; Beeharry, G. K.; Rajasekara, G. N.
The Astrophysical Journal Letters, Volume 719, Issue 1, pp. L41-L44 (2010)

Shibasaki, K.; Alissandrakis, C. E.; Pohjolainen, S. *Solar Physics*, Volume 273, Issue 2, pp.309-337 (2011)

Nicola Nosengo, *Nature News*, 17 February 2011 | *Nature* | doi:10.1038/news.2011.97

P. Zucca, E. Carley, J. McCauley, P. Gallagher, C. Monstein, *Solar Physics* (2012)

H. M. Bain, Säm Krucker, L. Glesener, and R. P. Lin, *The Astrophysical Journal*, Volume 750, Number 1, 2012

R. Ramesh, M. Anna Lakshmi, C. Kathiravan, et. Al., *The Astrophysical Journal*, 752:107 (6pp), 2012 June 20



Conclusions

- Network still growing, some new requests
- Geographical coverage to be improved, especially American/Pacific region
- Data quality improving (learning process)
- Apprentice of Dept.-Phys very much like Callisto production
- More science could be done (education?)
- Only little funding in Switzerland and neither UN nor NASA have funding left to further support instruments in developing countries.



Additional information:



<http://e-callisto.org>

Thank
you

