



# Dynamos and electric currents in the Sun Earth System and use of magnetic indices



Christine Amory-Mazaudier  
LPP/Polytechnique/UPMC/CNRS  
[Christine.amory@lpp.polytechnique.fr](mailto:Christine.amory@lpp.polytechnique.fr)



# International Space Weather Initiative

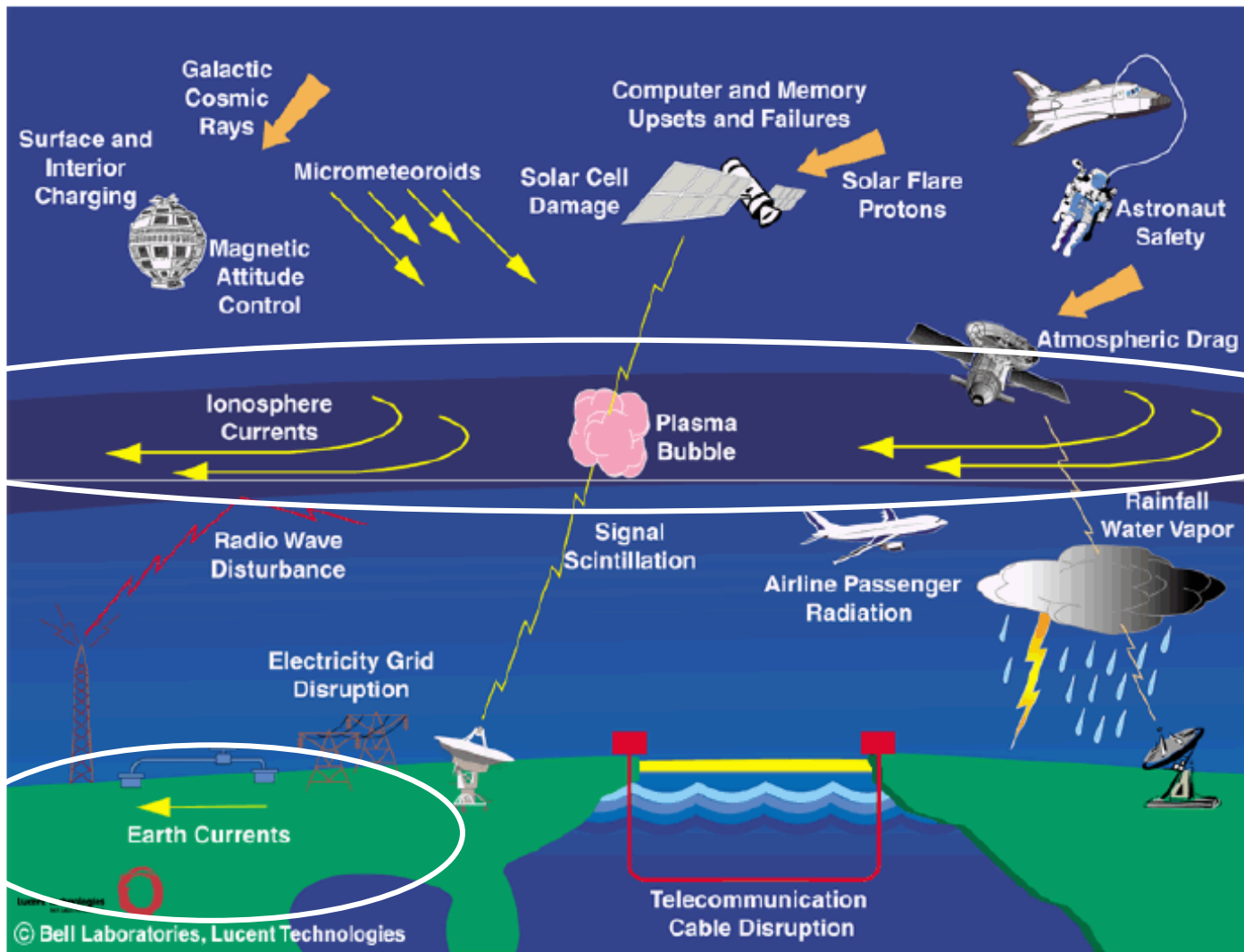

**Space weather includes many disciplines of the  
Physics**

**Solar physics**

**Studies on solar wind**

**Magnetospheric physics**

**Ionospheric studies**

**Atmospheric physics**

**Geomagnetism**

**Magnetotelluric studies, Geology**

**GNSS**

**Etc...**

# External currents systems are complex they involved

Sun, Solar Wind, Magnetosphere, Ionosphere, Atmosphere

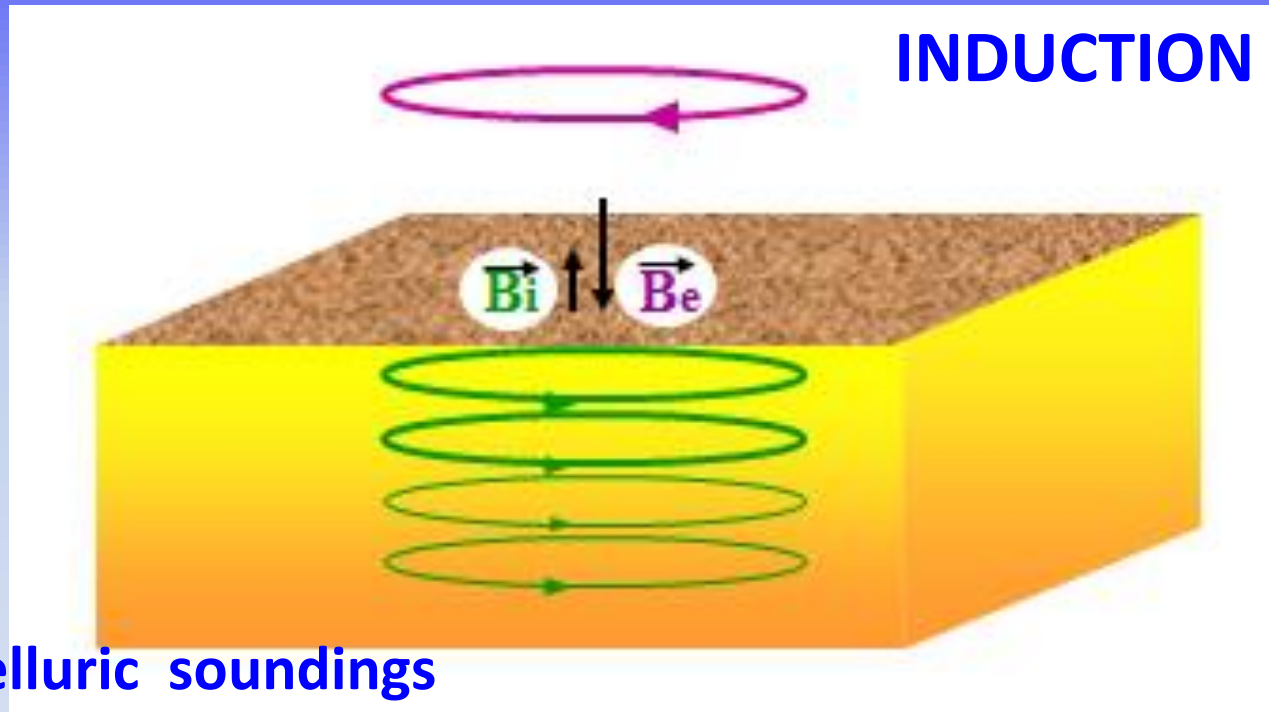

Magnetotelluric soundings

**GIC : Ground Induced Current  
Use in prospection (Geology )**

# MAGNETIC STORM OF MARCH 15, 1989

The auroral oval extends toward low latitudes

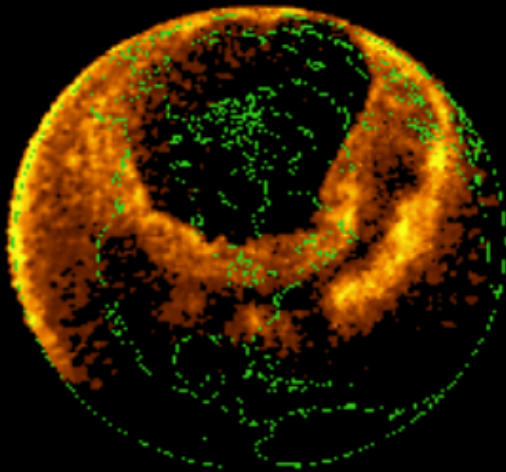
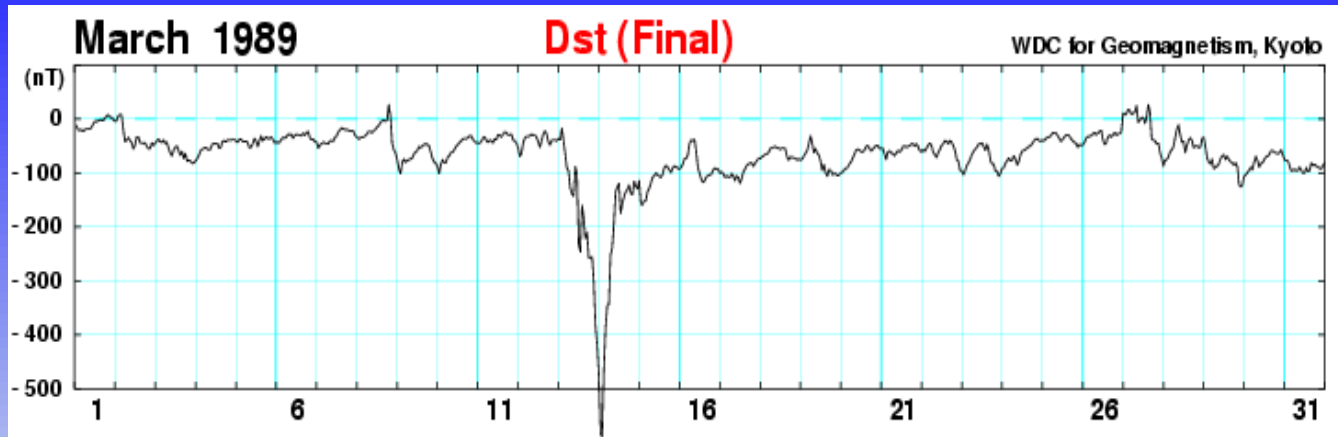

**March 13, 1989 - The Quebec Blackout Storm** - Most newspapers that reported this event considered the spectacular aurora to be the most newsworthy aspect of the storm. Seen as far south as Florida and Cuba, the vast majority of people in the Northern Hemisphere had never seen such a spectacle in recent memory. Electrical ground currents created by the magnetic storm found their way into the power grid of the Hydro-Quebec Power Authority and the entire Quebec power grid collapsed. Six million people were affected as they woke to find no electricity to see them through a cold Quebec wintry night. This storm could easily have been a \$6 billion catastrophe affecting most US East Coast cities.

Space weather effects see the lecture of prof. Endawoke Yigenzaw



**Jean DORTOUS DE MAIRAN -17 33**  
**Academician -> reign of the king LOUIS XIV**

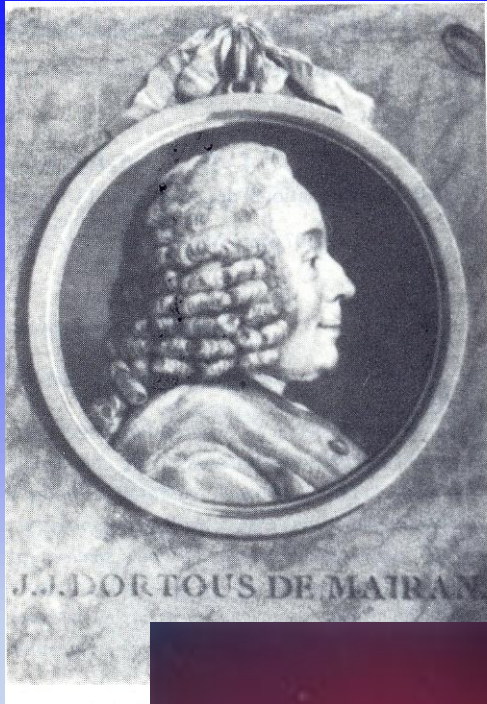

**explained  
the aurora**

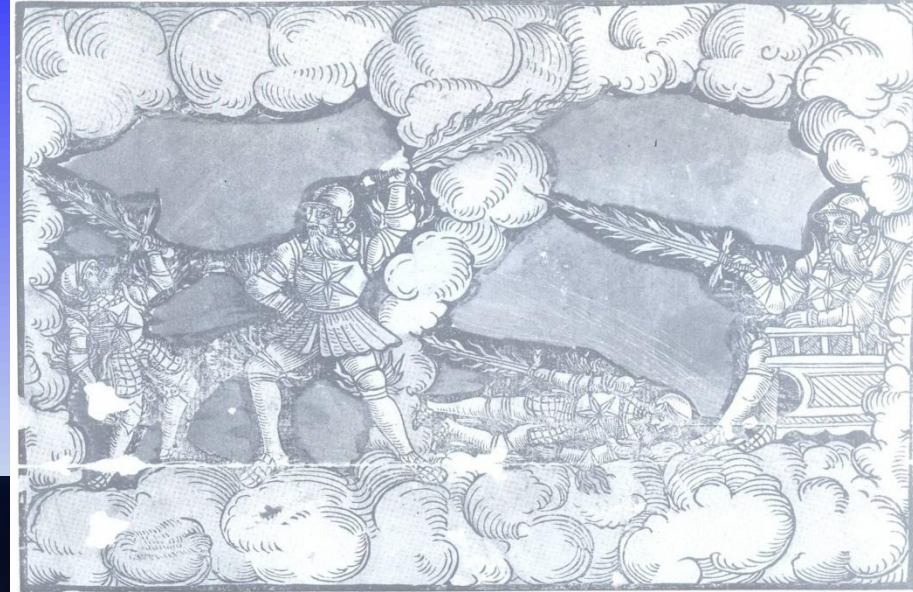

**Observed in France**  
**April, 11, 2001**



**Picture of the aurorae observed  
on Jule 24, 1554 in Germany and  
Switzerland**  
**Legrand et al. 1991**  
**The aurorae is at 100km height**



# OUTLINES

- Sun Earth System : a global electromagnetic complex system
- Dynamo process and large scale dynamos
- Electric currents associated to the different dynamos
- Magnetic field to approach electric currents
- Magnetic indices



# Sun Earth System

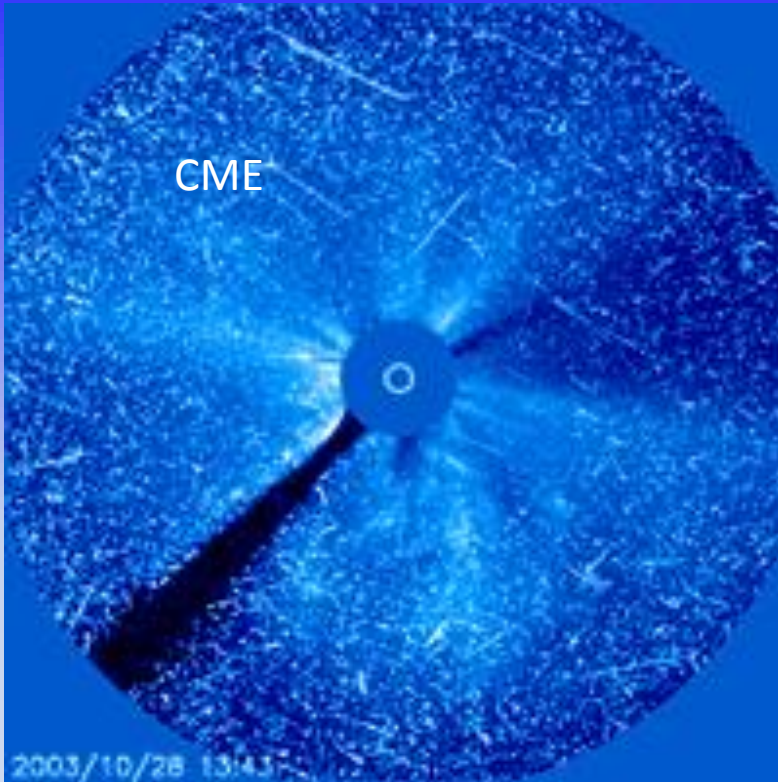

**Coronal mass ejection**

**Shock**

**Magnetic storms**

**Maps of the TEC over Asia**

**Images du satellite SOHO/NASA**

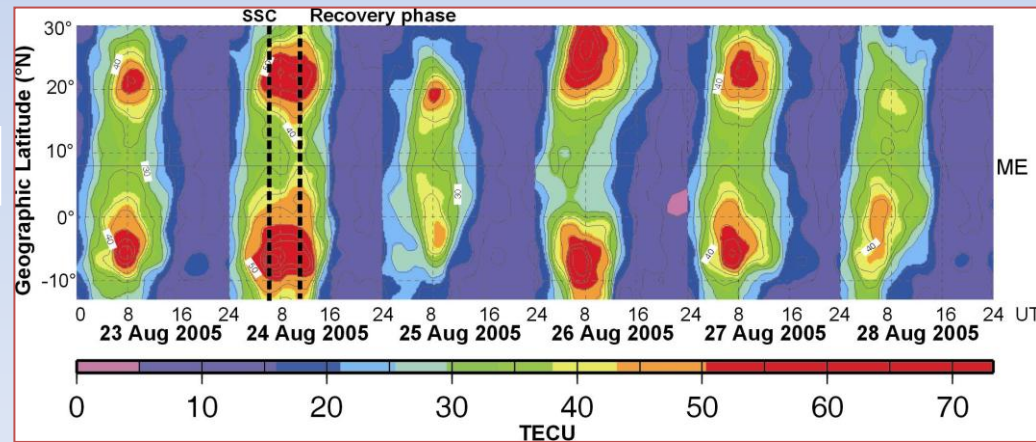

Amory-Mazaudier et al, 2006

# Sun Earth System

Coronal holes  
High speed solar wind

Solar Flare  
X ray ....

Geomagnetic disturbance due to  
A solar flare / black arrow

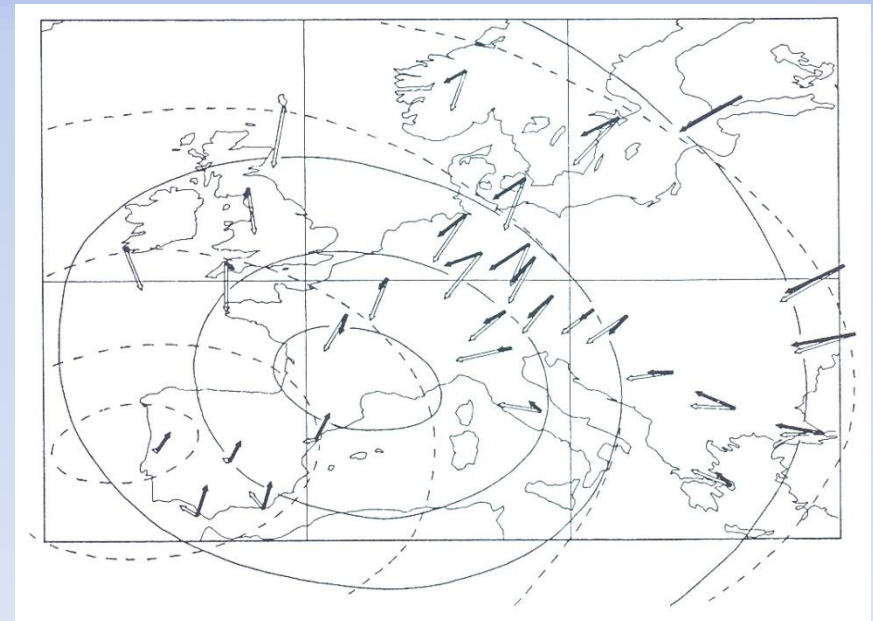
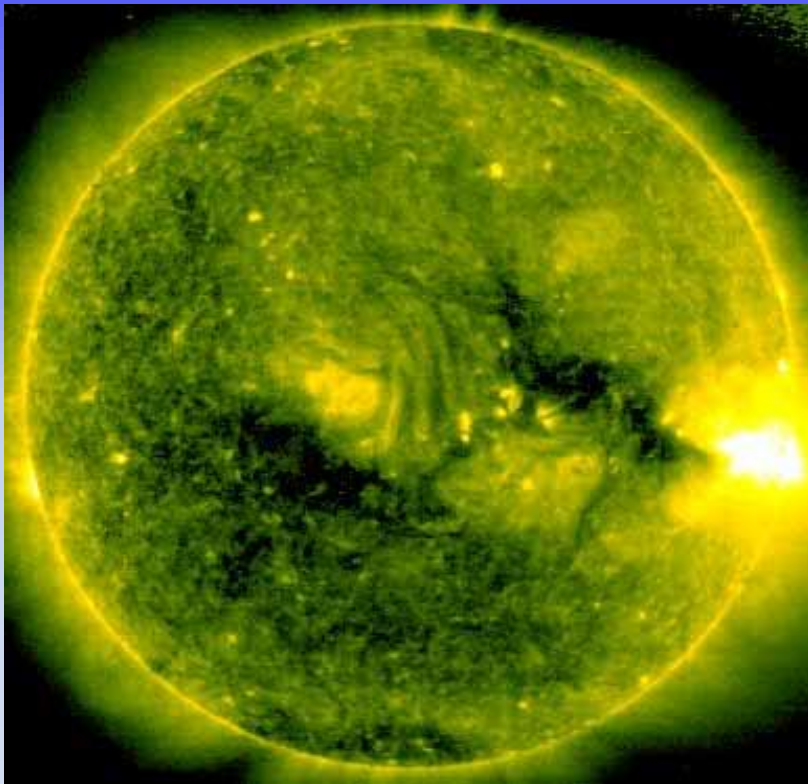

Images du satellite SOHO/NASA

# Sun Earth System

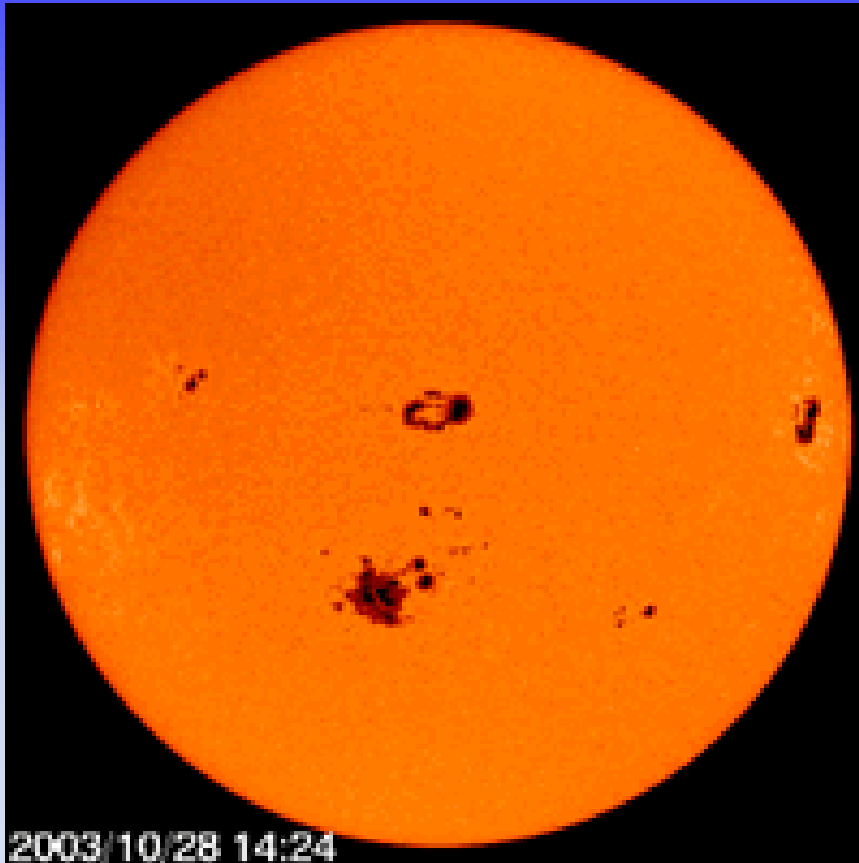

Images du satellite SOHO / NASA - ESA

## Sunspot Radiations EUV, UV Solar cycle

Regular variation of the Earth's magnetic  
Field at Phu Thuy/ Vietnam

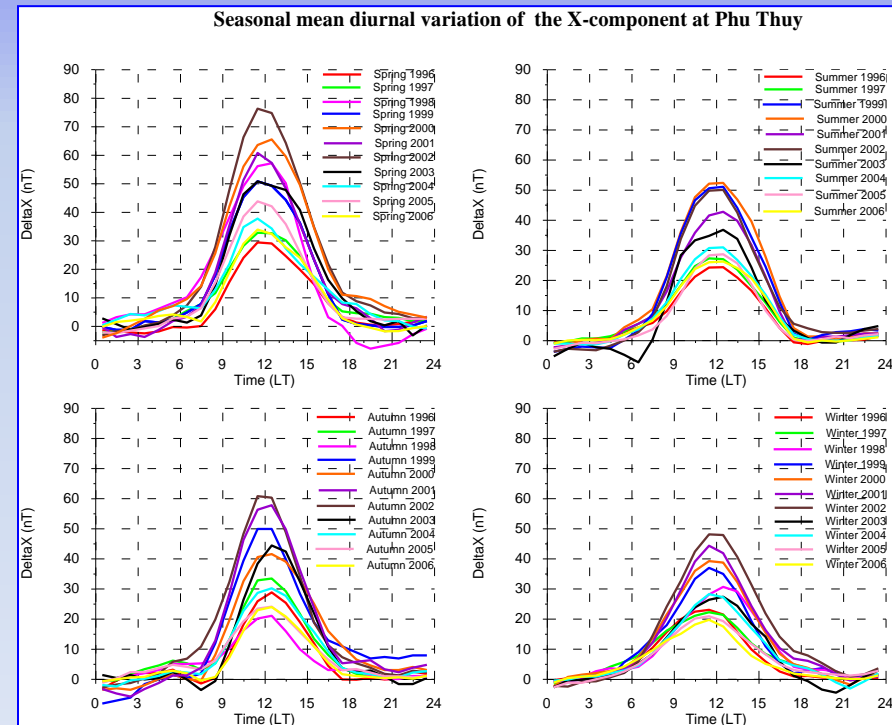

The Sun influences all the physical parameters of the Earth's environment through various physical processes.

To improve data analysis it is necessary to know the physical processes acting in the global Sun Earth' system when the data are recorded.

# Starting point

MOTION

V

B

MAGNETIC FIELD

$V \times B$

Dynamo Electric field

LORENTZ 'S FORCE  
 $j \times B$

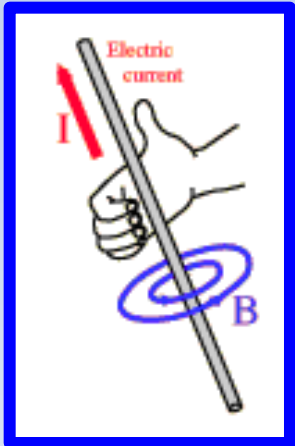

FARADAY'S LAW  
 $\nabla \times E = -\delta B / \delta t$

Polarisation Electric field

E

OHM'S LAW  
 $j = \sigma (E + V \times B)$

j

AMPERE'S LAW  
 $\nabla \times B = \mu j$

B

## Principle of the DYNAMO ACTION



# Outlines

- Sun Earth System : a global electromagnetic complex system
- Dynamo process and large scale dynamos
- Electric currents associated to the different dynamos
- Magnetic field to approach electric currents
- Magnetic indices

- $B = B_p + B_a + \text{Be} + B_i$

In this section we will present the main dynamos at the origin of Be

**B<sub>p</sub> : Main field (core)**  
**B<sub>a</sub> : Aimantation field (Listosphère)**  
**Be : field related to external sources**  
**B<sub>i</sub> : induced by Be**

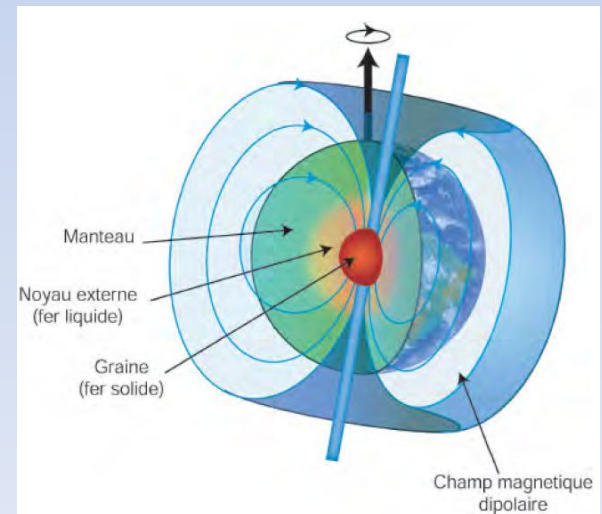

# **SOLAR DYNAMO**

**see the lecture of Prof. Munoz**

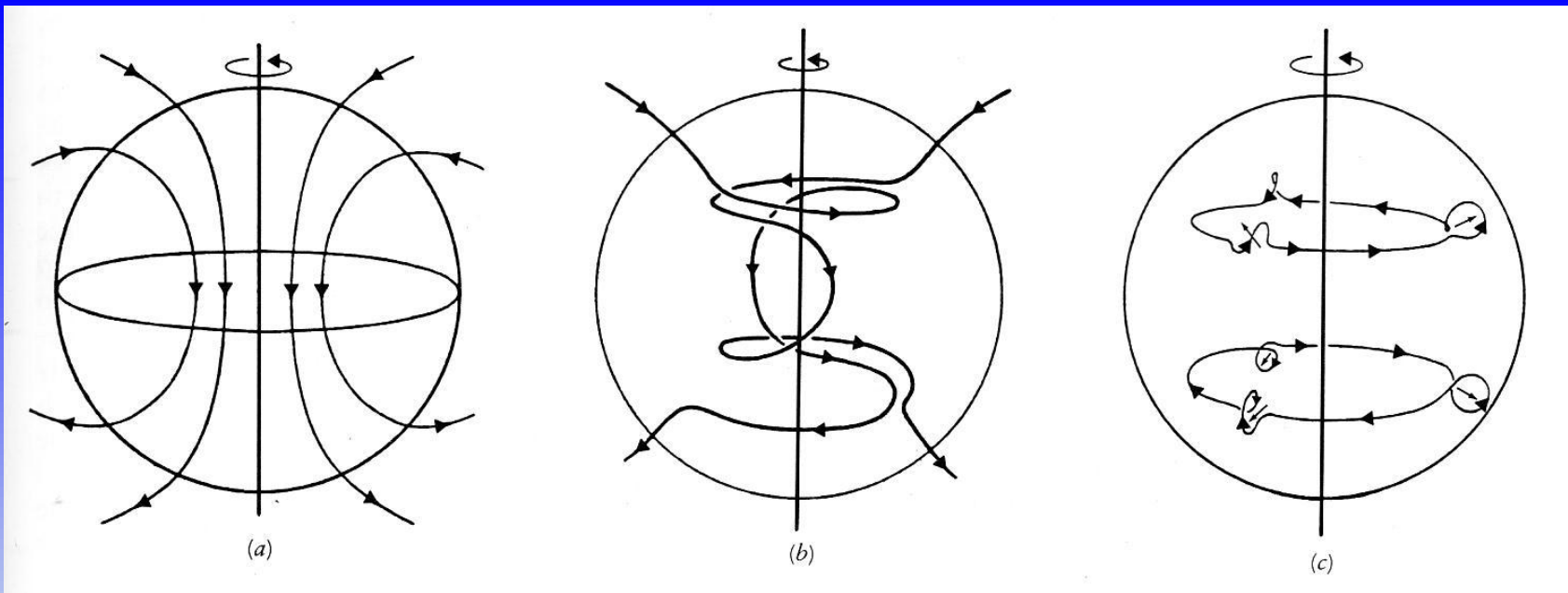

**Poloidal field**

**Toroidal field**

**SOLAR DYNAMO**

**Friedman 1987**

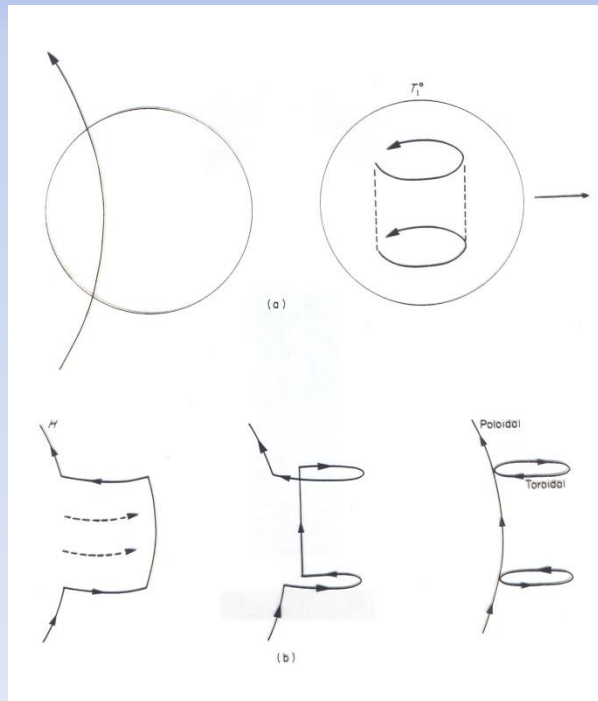

<http://solarscience.msf.nasa.gov/dynamo.shtml>

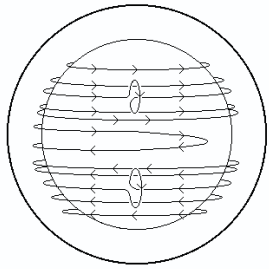

The  $\alpha$ -effect

Twisting of the magnetic field lines is caused by the effects of the Sun's rotation  $\alpha$

Diagram from L. Paterno, 2006

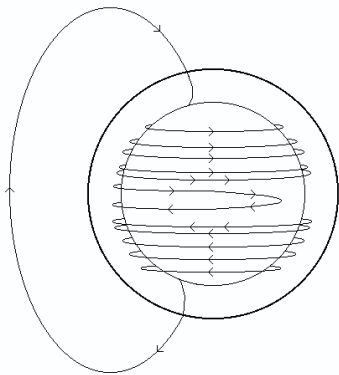

The  $\omega$ -effect

Differential rotation change in rotation rate as a function of latitude and radius within the Sun  $\omega(r, \theta)$

**The solar dynamo ingredients**  
**Motions : rotation and convection**  
**Magnetic field : dipolar component**

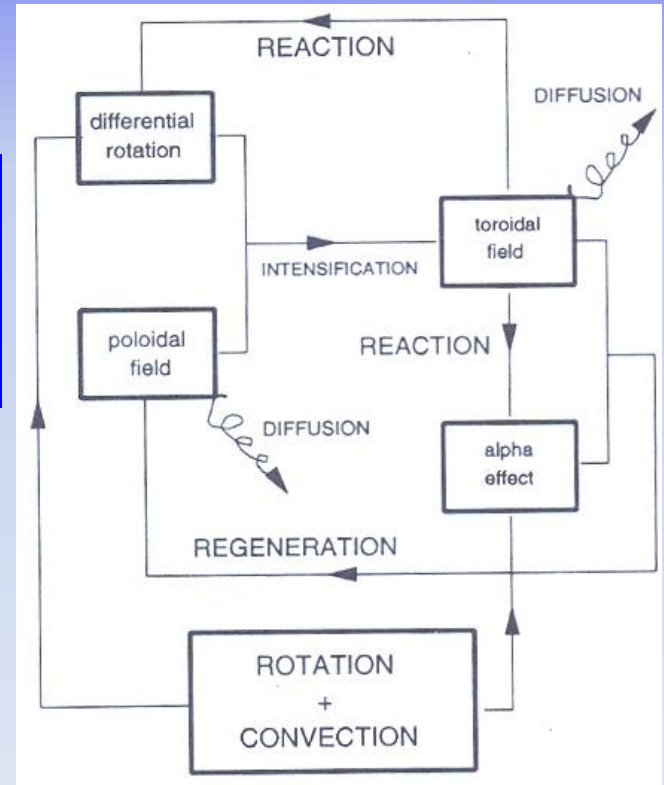



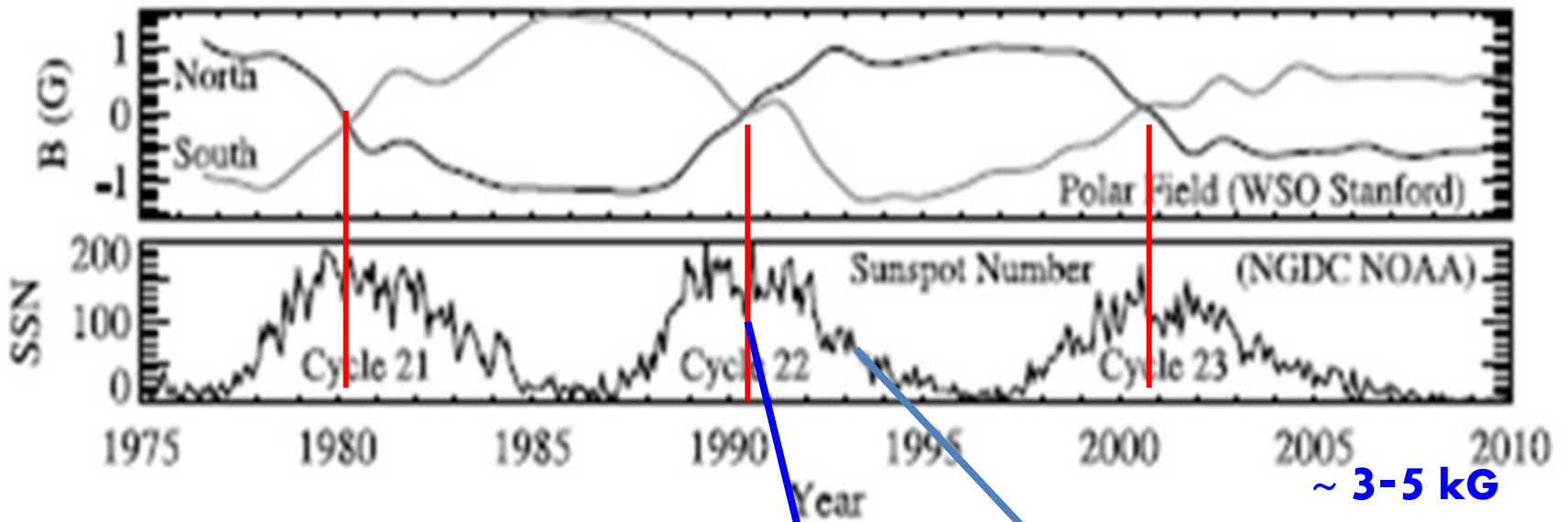
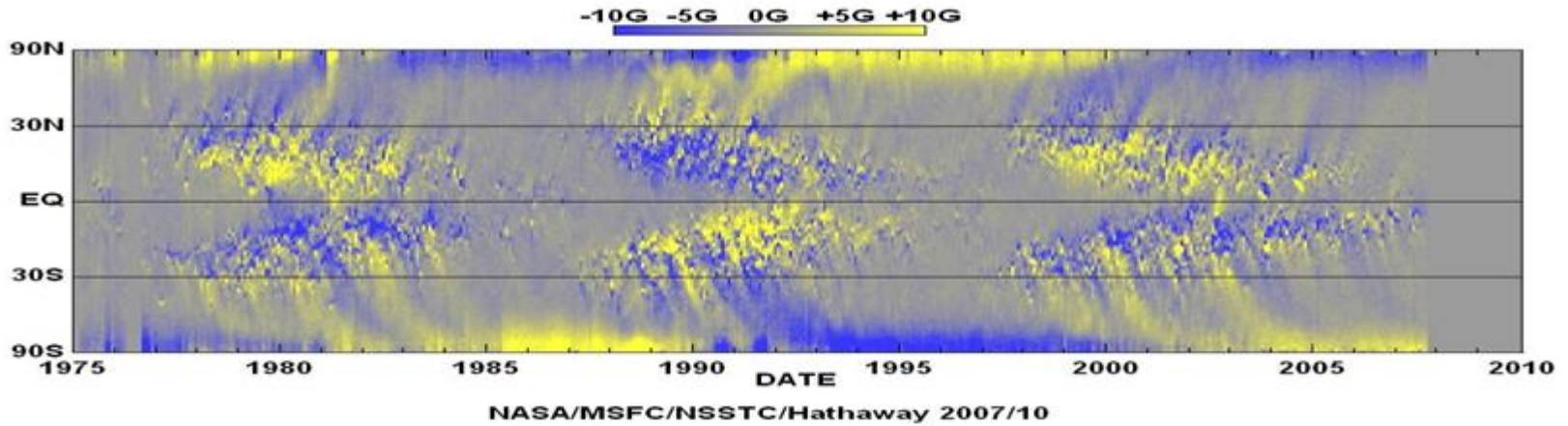

Luhmann et al., 2011

**CME**

**High solar wind streams**

**It is a necessity to reanalyze  
all the ionospheric data, taking into  
account new knowledge on the SUN**

**Geophysics -> heliophysics**

**International Heliophysics Year**

# **Solar Wind – Magnetosphere Dynamo**

**see the lectures of Prof. Miyoshi  
and Prof. Kikuchi**

# The Solar wind magnetosphere Dynamo

## Magnetic storm

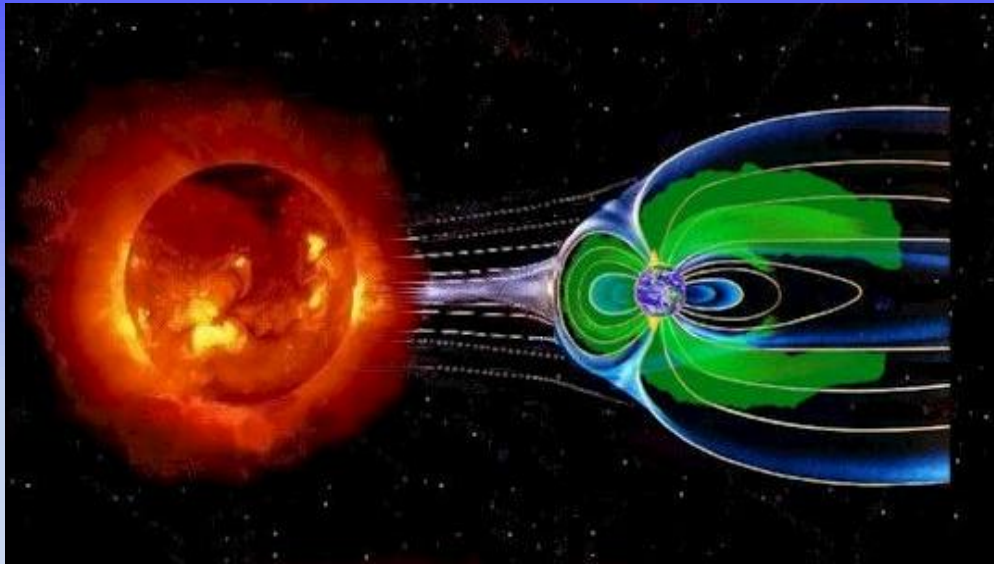

$$\mathbf{E} = -\mathbf{V}_s \times \mathbf{B}_i$$

$\mathbf{V}_s$  : Solar wind ,  
 $\mathbf{B}_i$  : magnetic field of  
interplanetary medium

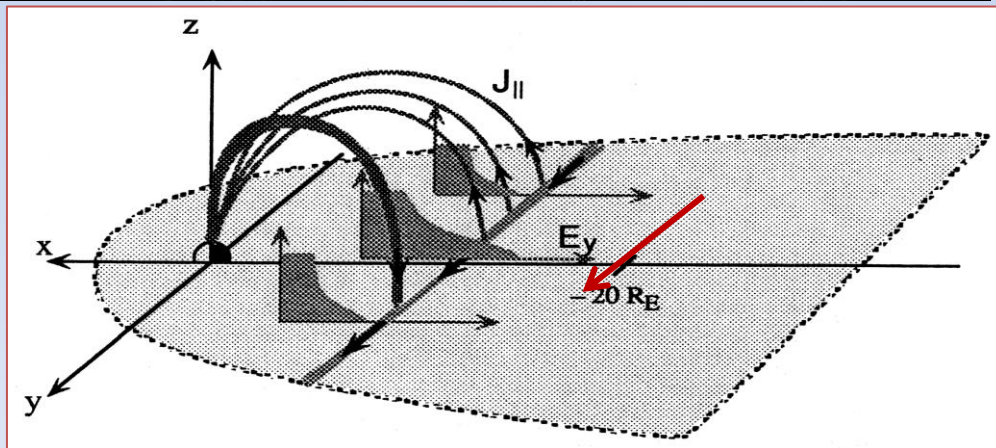

Component  $B_z$  of the  
interplanetary  
directed toward the south  
is a condition for a  
magnetic storm in the  
majority of the cases.

Frame of the magnetosphere

# Solar wind – magnetosphere dynamo is continuously acting

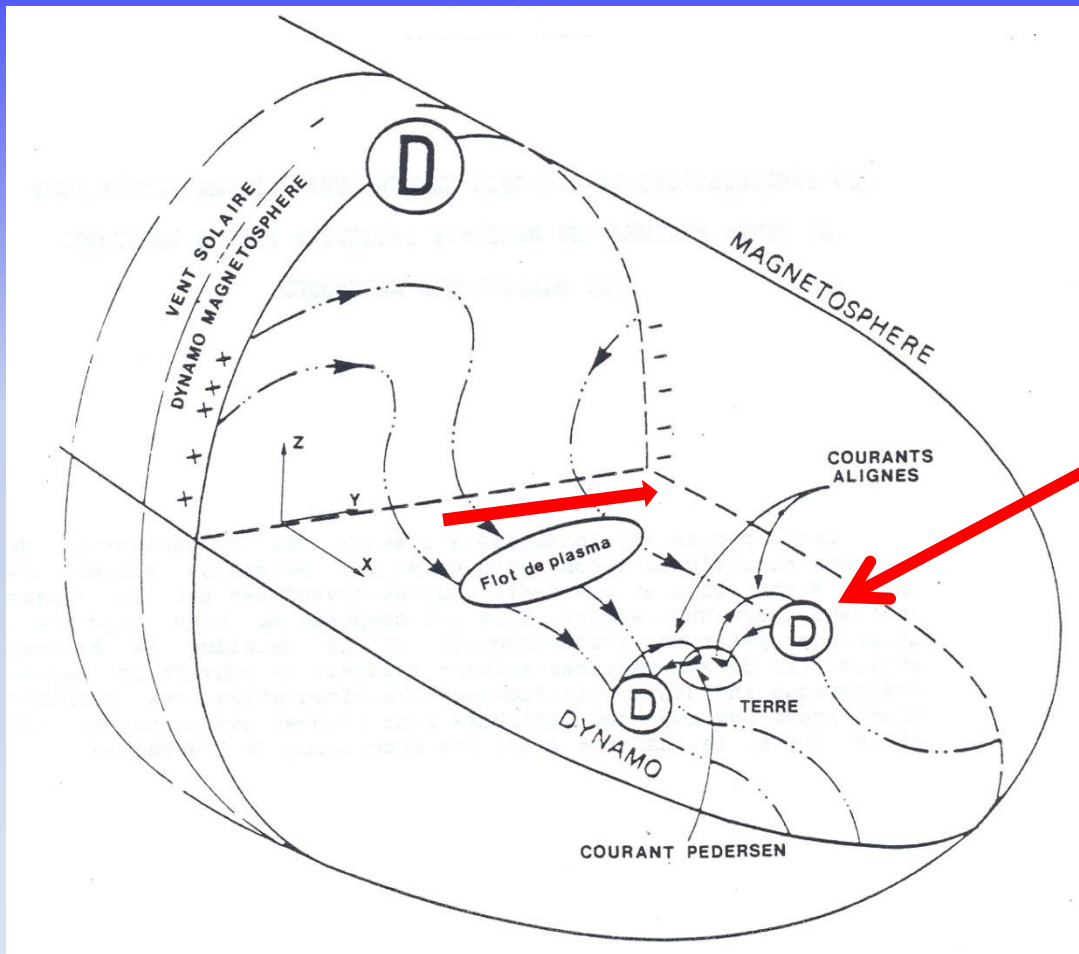

Secondary dynamos

Motion of particles from the tail to the Earth  
ExB drift



# The solar wind magnetosphere dynamo / Theories

**Always acting**

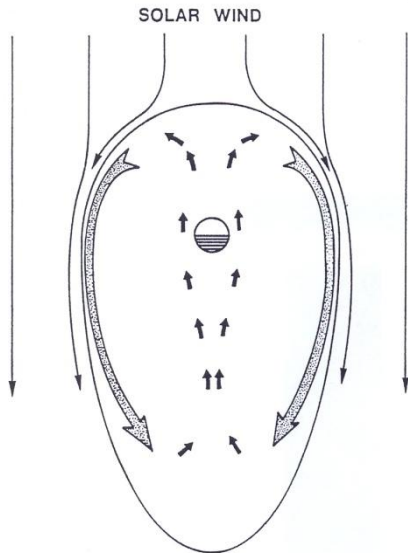

Viscous interaction between the solar wind and the magnetosphere, Axford and Hines, 1961. Interplanetary electric field transmitted to the magnetosphere :  $E = -V_s \times B_i$   
**Other process -> reconnection Dungey 1961**  
**Connection between the interplanetary magnetic field and the Earth's magnetic field**

This process is based on a closed magnetosphere  
Today the magnetosphere is considered a open

**These 2 processes produce motions of particles in the magnetosphere -> electric currents**

**More efficient**

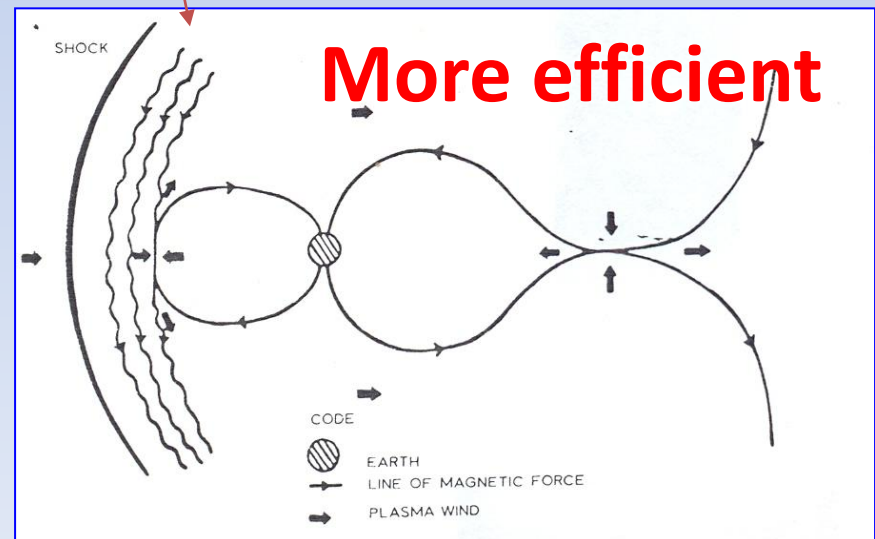

**ATMOSPHERIC WIND**  
**IONOSPHERIC DYNAMO**

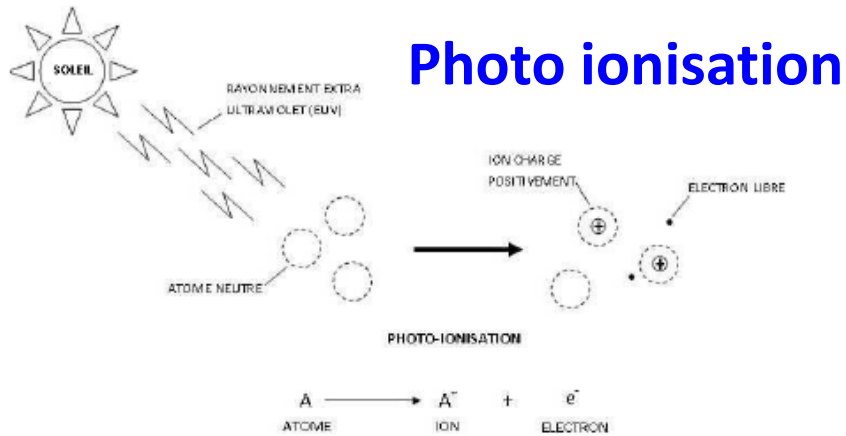
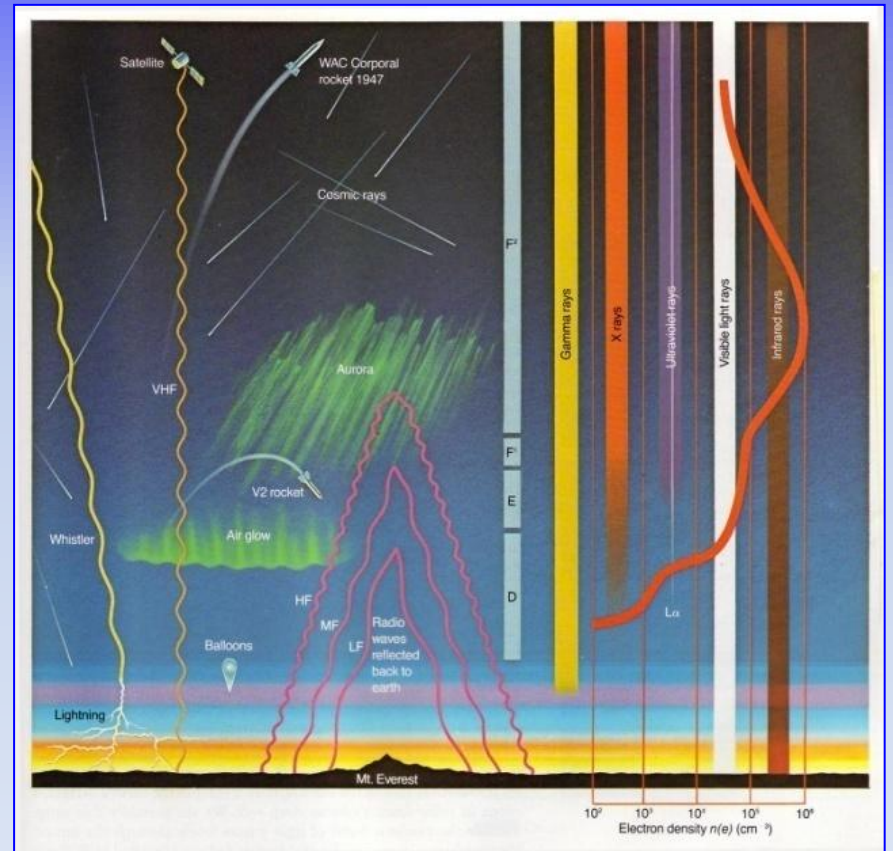
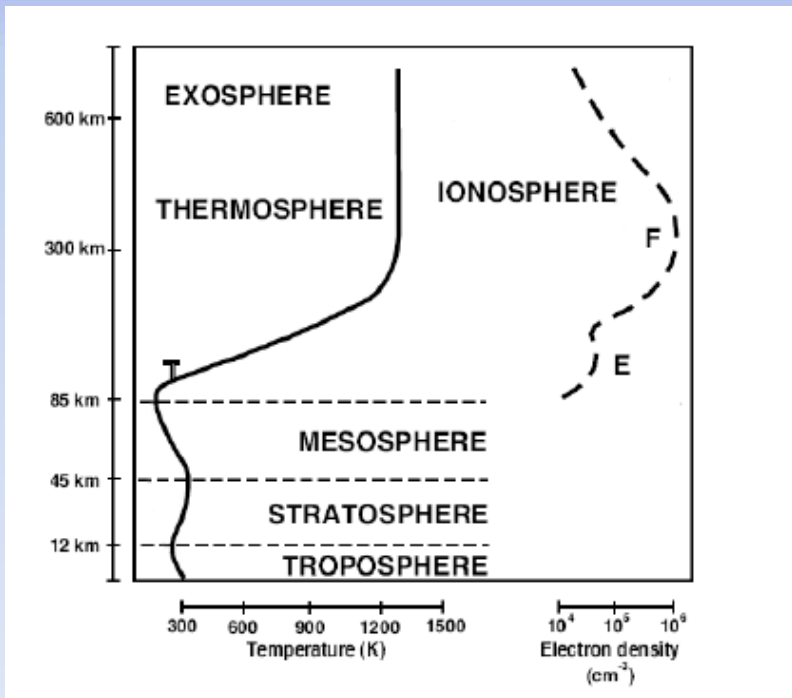

FIGURE 1.6 - Photoionisation d'un atome neutre A, par un rayonnement ultraviolet extrême (EUV) du soleil, produisant un ion chargé positivement A<sup>+</sup> et un électron libre e<sup>-</sup>.

# IONOSPHERIC DYNAMO SOLAR RADIATIONS UV, EUV



# IONOSPHERIC DYNAMO: Conductive layer

Motion of the neutral atmosphere

$V_n$

$B_t$

Earth's magnetic field

DYNAMO electric field

$V_n \times B_t$

$E$

POLARISATION electric field

## IONOSPHERIC OHM'S LAW

$$\vec{J} = \sigma_p (\vec{E}_\perp + \vec{V}_n \wedge \vec{B}) + \sigma_h \vec{b} \wedge (\vec{E}_\perp + \vec{V}_n \wedge \vec{B}) + \sigma_{||} \vec{E}_{||}$$

$$\sigma_p = \frac{N_e e}{B} \left( \frac{v_{in} \Omega_i}{v_{in}^2 + \Omega_i^2} + \frac{v_{en} \Omega_e}{v_{en}^2 + \Omega_e^2} \right)$$

$$\sigma_h = \frac{N_e e}{B} \left( \frac{\Omega_e^2}{v_{en}^2 + \Omega_e^2} - \frac{\Omega_i^2}{v_{in}^2 + \Omega_i^2} \right)$$

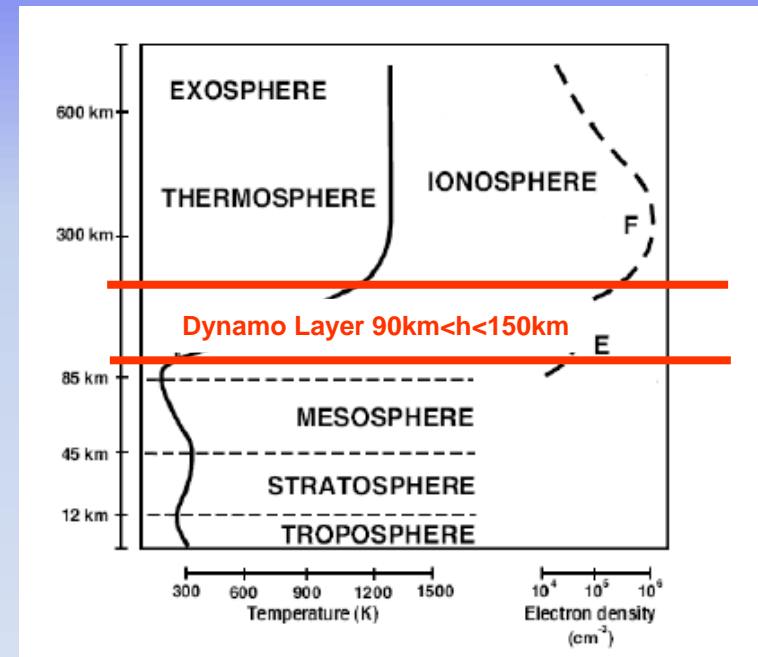

$$\Omega_e = \frac{eB}{m_e}$$

$$\Omega_i = \frac{eB}{m_i}$$

Gyrofrequencies of electrons and ions

$\sigma_p$ : Pedersen conductivity  $\perp B$  et  $\parallel E$

$\sigma_h$ : Hall conductivity  $\perp B$  et  $E$

$v_{in}$  et  $v_{en}$ : collisions frequencies

# IONOSPHERIC DYNAMO / Neutral winds

## Stratosphere Atmospheric Tides, Evans 1977

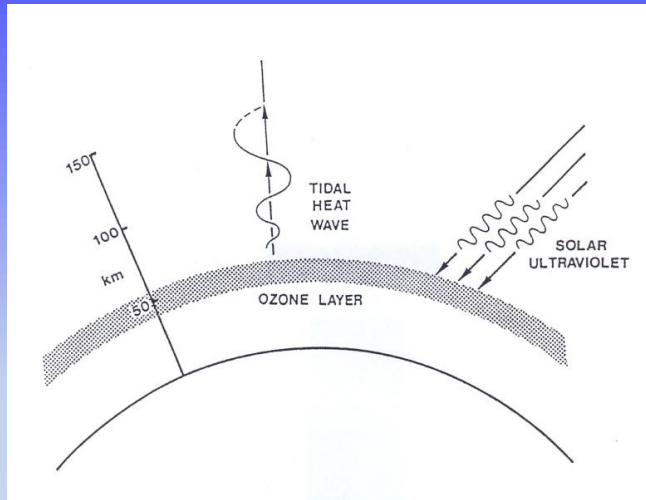

Diurnal process  
E Region of the  
Ionosphere  
(90km < h < 150km)

## Deep convection in the troposphere : non migrating tides

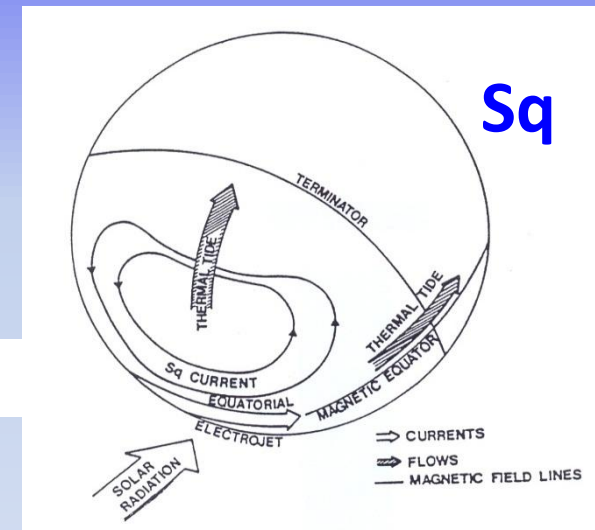
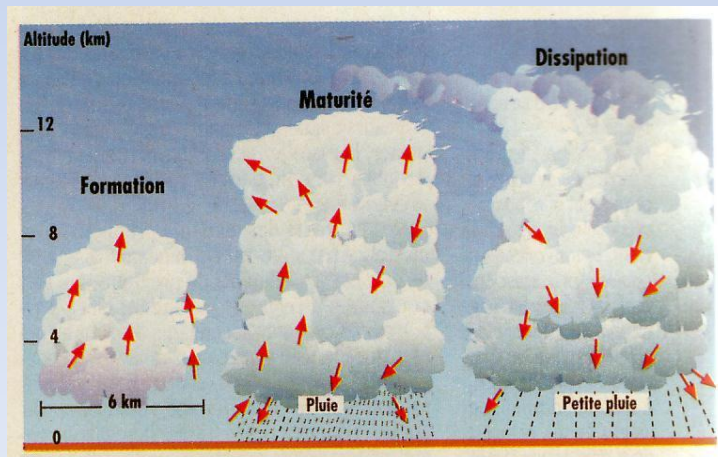

Vertical coupling  
Dynamics of the Atmosphere  
Ionospheric Electrodynamics  
Atmospheric electricity  
**Field to investigate**

# EARTH' s DYNAMO



# EARTH'S DYNAMO

Earth's magnetic field known since more 2 millenaries

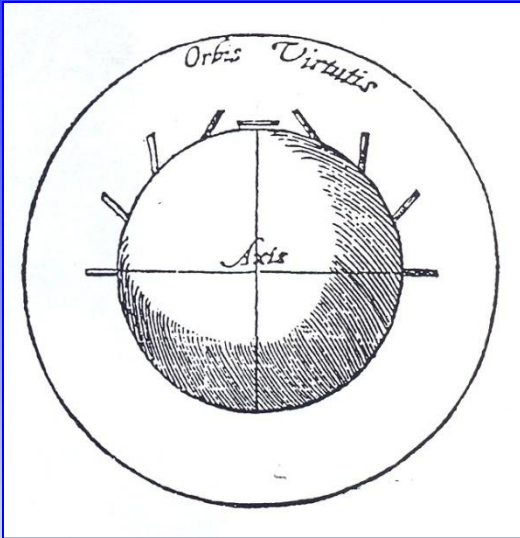

Gilbert, 1600 -> Dipole

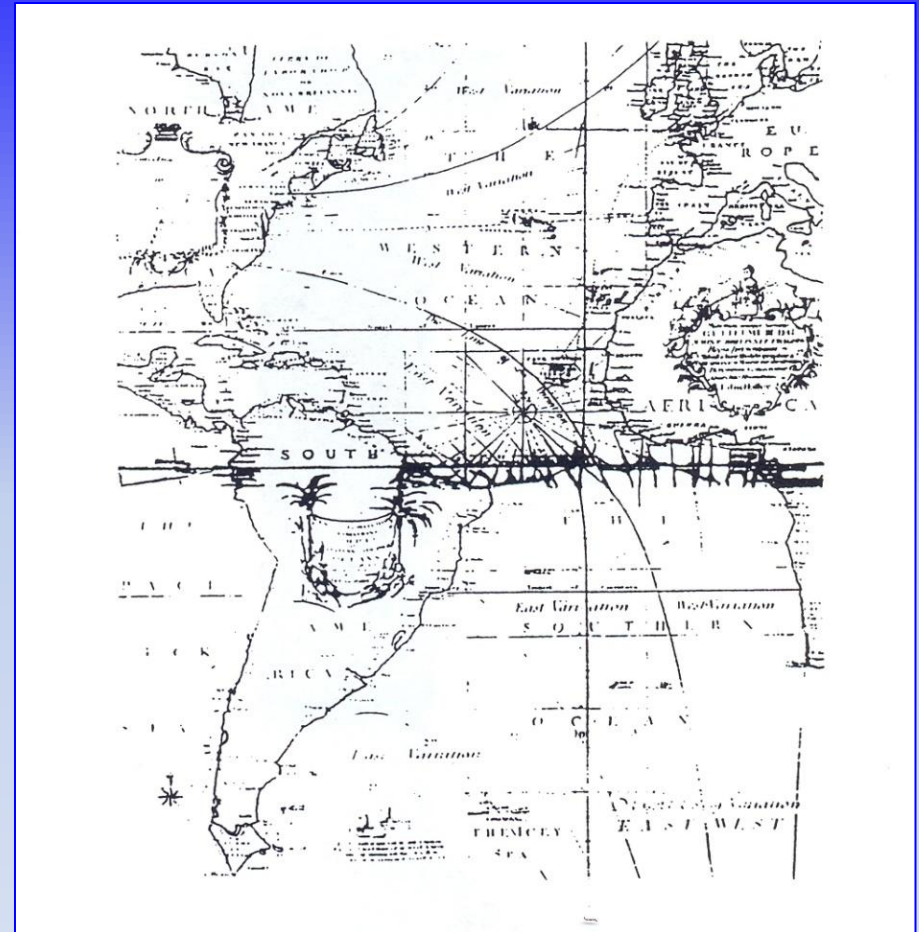

First map of the Earth's magnetic field Halley 1701

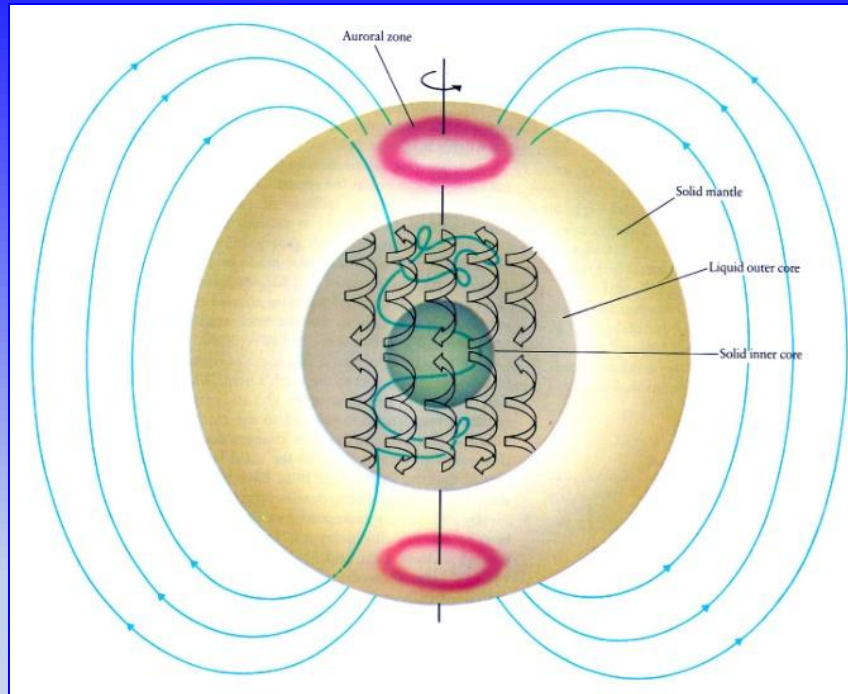

**Internal Earth's dynamo ->  $B_p + B_a$**

**$B_p$  : main field ,  $B_a$  : aimantation field (Lithosphere)**

**IGRFmodel**

**[http://www.iugg.org/IAGA/iaga\\_pages/pubs\\_prods/igrf.htm](http://www.iugg.org/IAGA/iaga_pages/pubs_prods/igrf.htm)**

Dynamo	Motions – V	Magnetic field B	Order of Magnitude
Sun	Sun Rotation and convection	Sun : 2 components Dipolar Toroidal = sunspot	rotation speed : ~ 7280km/h at the equator Dipolar component : ~10 G Toroidal component : ~3-5 kG
Solar wind Magnetosphere	Solar wind	Interplanetary medium -> B <sub>i</sub>	speed ~ [ 400km/s to 1000km/s] B <sub>i</sub> ~ qq 10 nT
Atmospheric wind Ionosphere	Atmosphere	Earth's -> B <sub>t</sub>	speed ~ 100m/s B <sub>t</sub> ~ qq 10 000 nT
Earth's Dynamo inside the Earth	Metallic core	Earth's -> B <sub>t</sub>	Indirect measurements deduced from the Earth's planetary magnetic field and the secular variation Velocity ~ qq km/year B <sub>t</sub> ~ qq 10 000 nT

# OUTLINES

- Sun Earth System : a global electromagnetic complex system
- Dynamo process and large scale dynamos
- Electric currents associated to the different dynamos
- Magnetic field to approach electric currents
- Magnetic indices

# Solar wind magnetosphere dynamo (Vs, Bi)

## Electric currents in the magnetosphere

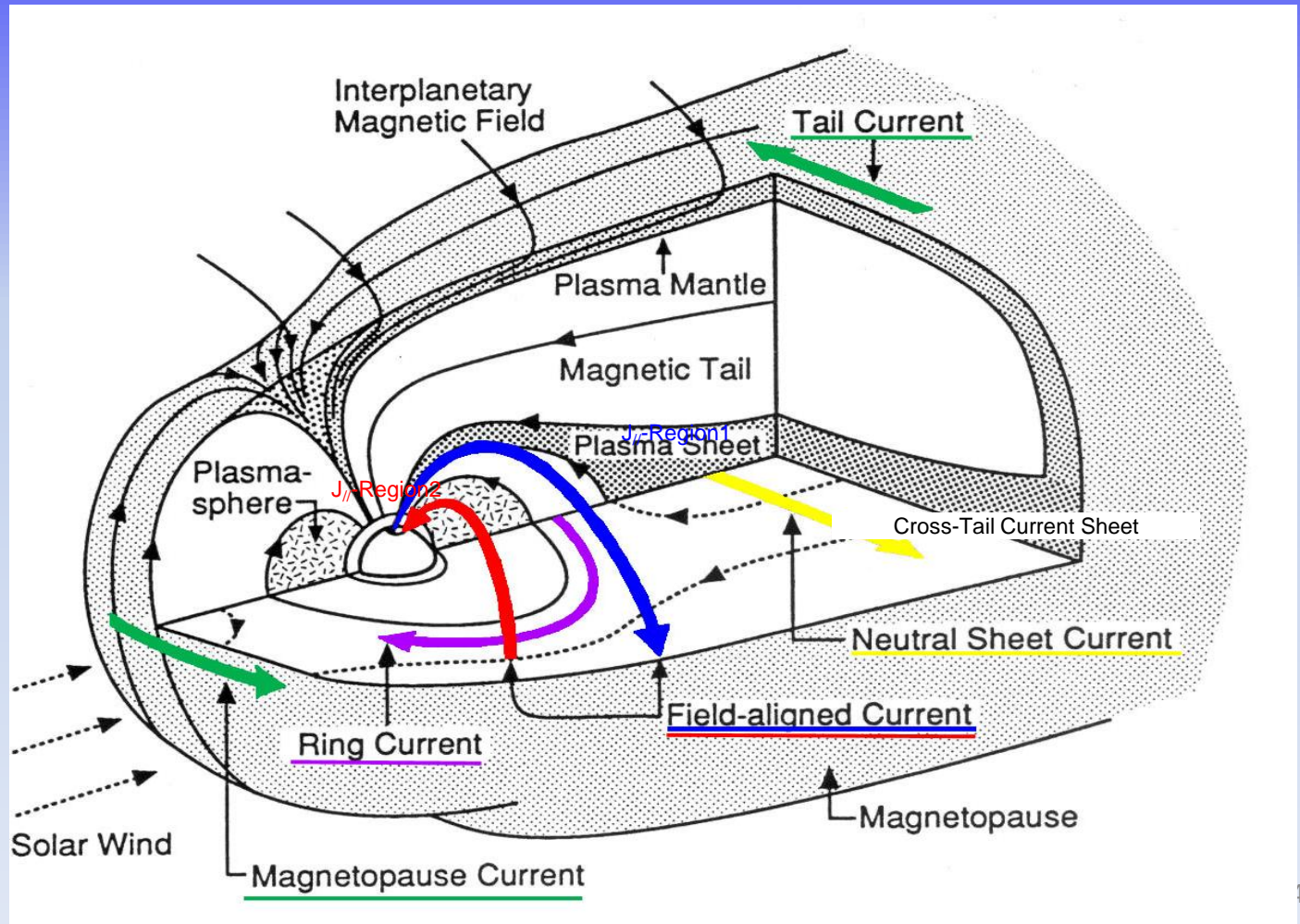
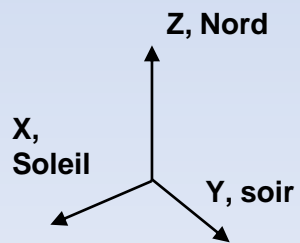



# Chapman Ferraro currents/ 1935 Noze of the Magnetopause

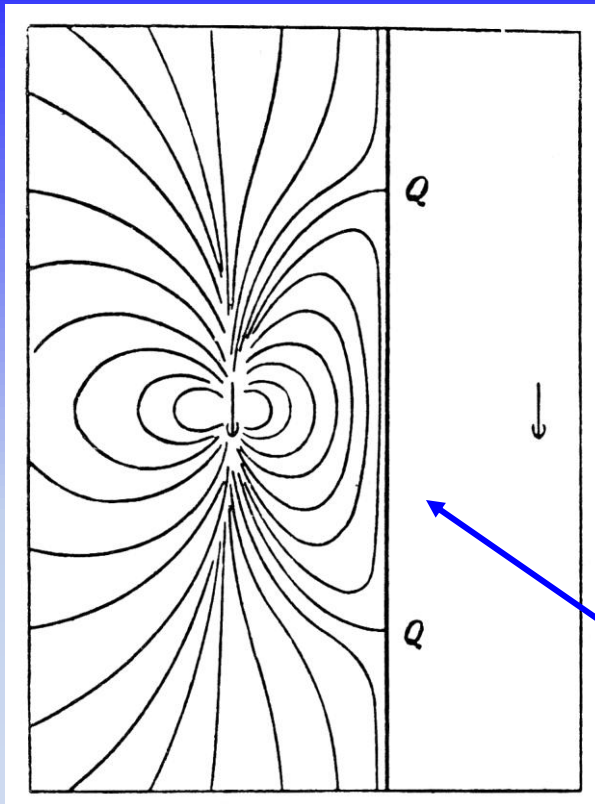

2 dimensional  
conducting sheet

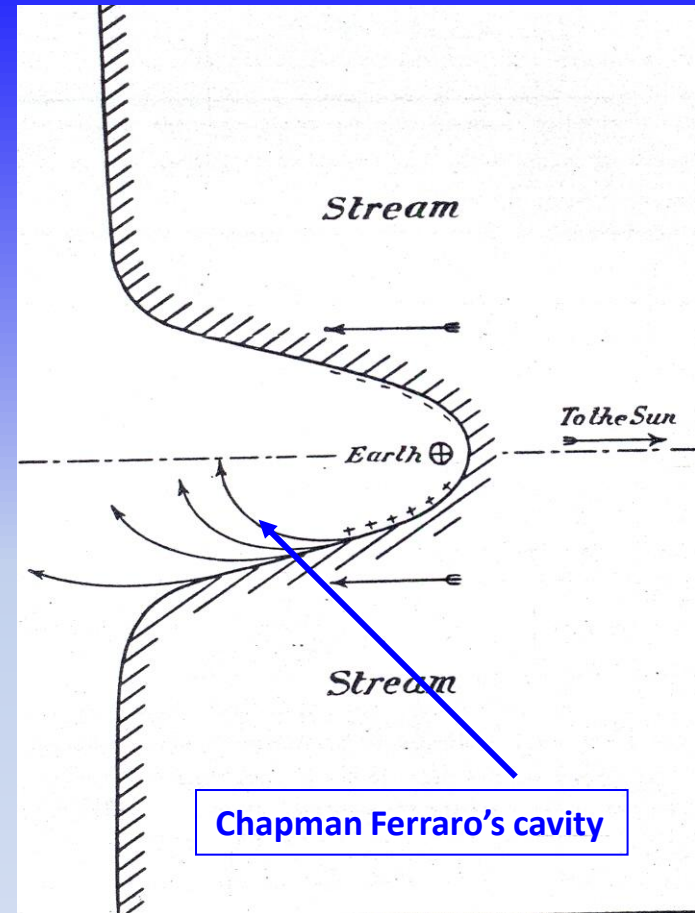

Chapman Ferraro's cavity

Chapman and Ferraro in 1935 explained magnetic storms by the interaction of a cloud of neutral mixture and ions and electrons (today named plasma) approaching the Earth's dipole. When the cloud of 'plasma' approaches the Earth, electric currents would be induced in it, producing magnetic disturbances.



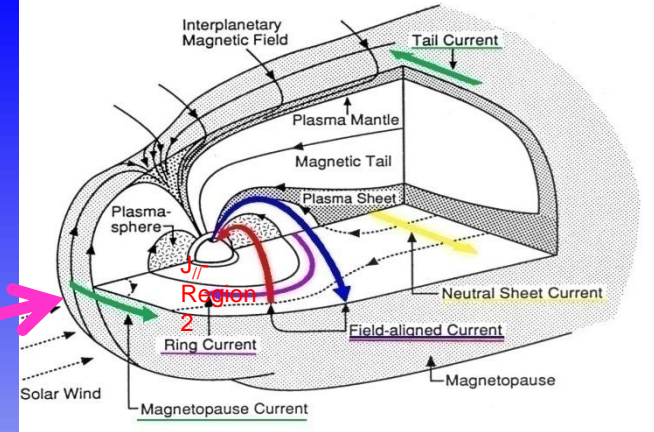
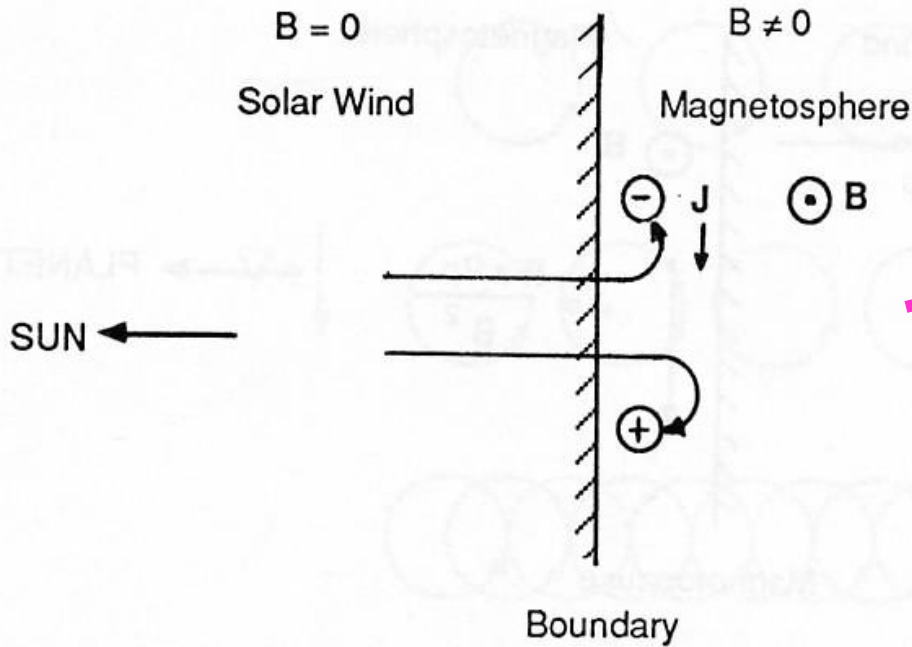

See lecture of Prof. Watanabe

The Chapman Ferraro currents flow in the Magnetopause layer, the boundary between the solar wind and the geomagnetic field. At the nose of the magnetopause the geomagnetic field pressure is balanced by the dynamic pressure of the solar wind

$$K_1 N_{im} V_i^2 = \frac{B_{mp}^2}{2\mu_0}$$

dynamic pressure of the solar wind  $\Leftrightarrow$  geomagnetic field pressure

$K_1$  is the correction factor for flow deflection in magnetosheath and compression of B. The order of magnitude of the Chapman Ferraro current is  $\sim 30$  nT (Gosling et al. 1990).

# Ring current

Dawn-dusk voltage drop difference to the magnetosphere



Particles follow trajectories from the tail of the magnetosphere toward the Earth



In the region where the curvature and gradient of the Earth's magnetic field are strong, particles are separated, the electrons are diverted to the morning side and the ions to the evening side.

## Formation of the ring current

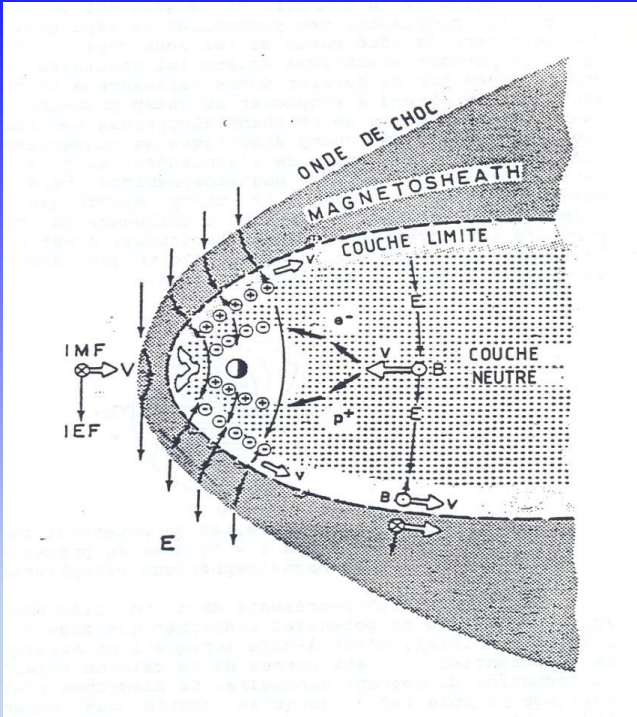

The expression of the drift due to gradient and curvature and the resulting current is:

$$\vec{V}_{gc} = \frac{1}{2} m V_{\perp}^2 \frac{B \times \nabla B}{q B^3} + m V_{LL}^2 \frac{B \times (b \cdot \nabla) \hat{b}}{q B^2}$$

$$J_{gc} = N q V_{gc}^{ions}$$

This current is mainly carried by ions.

There is also an additional contribution of the magnetic moments of all particles:

$$\vec{M} = -N_i \frac{1}{2} \frac{m_i V_{i\perp}^2}{B} \hat{b} - N_e \frac{1}{2} \frac{m_e V_{e\perp}^2}{B} \hat{b}$$

$$\vec{J}_m = \nabla \times \vec{M}$$

The ring current keeps the pressure gradient and the Lorentz force in balance.

# Tail currents / 1972

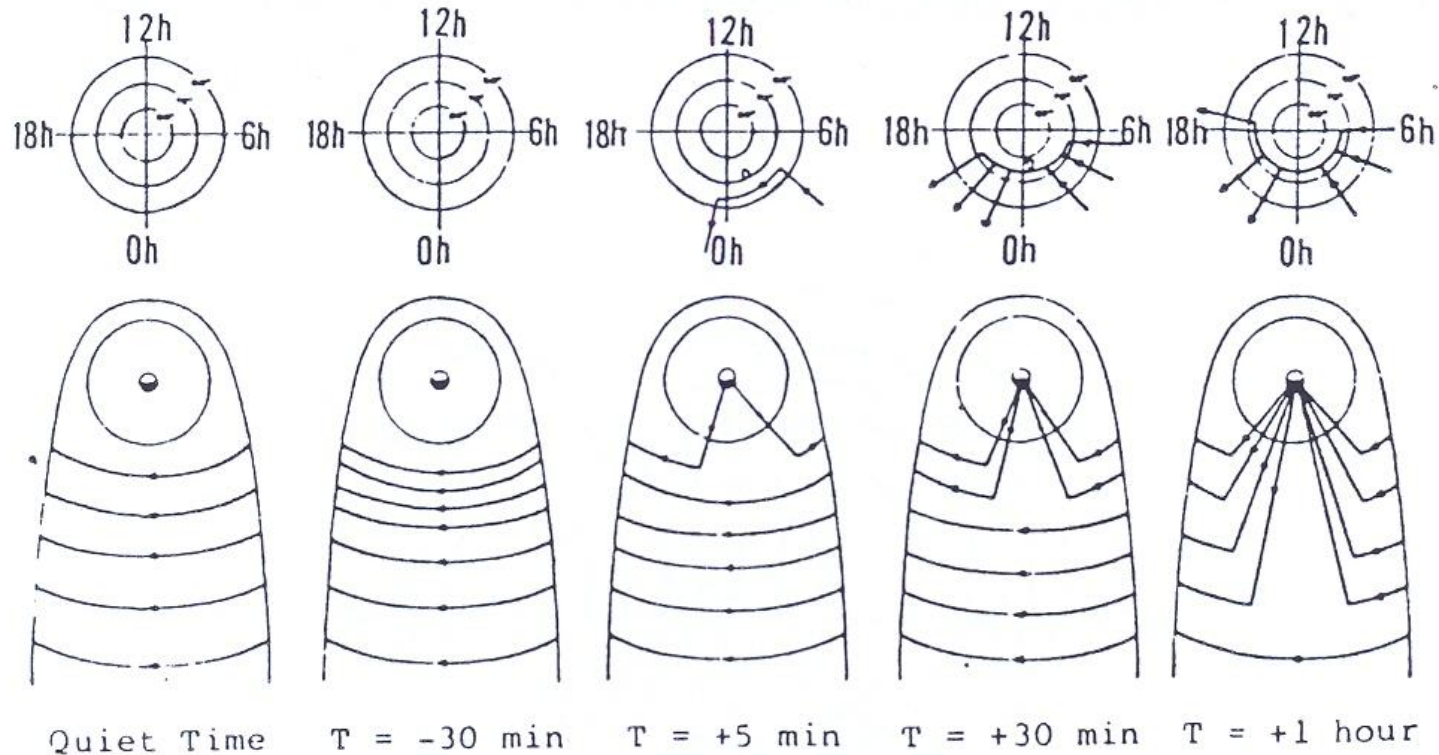

**Proposed by Akasofu in 1972, the tail currents flowing at the boundary of the plasma sheet are disrupted and deflected toward the Earth on the evening side. These currents via Birkeland (field aligned current) be converted to a westward electrojet**



# Tail currents

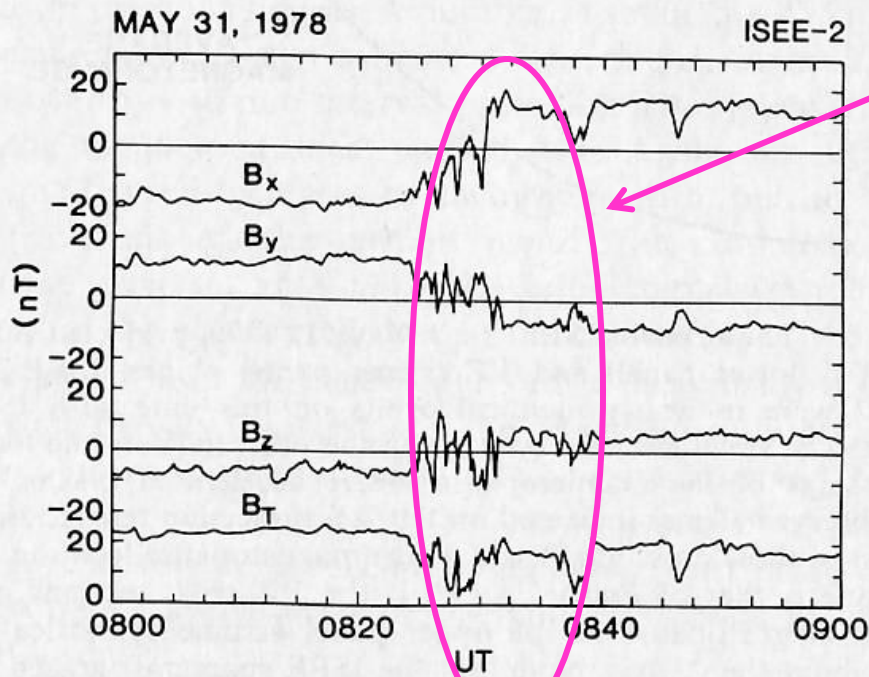
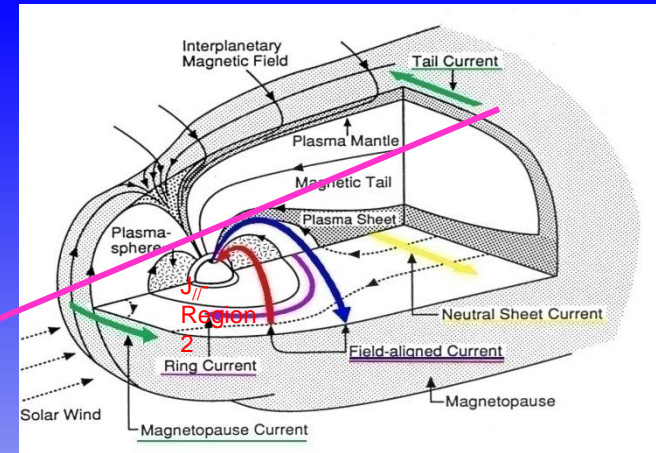
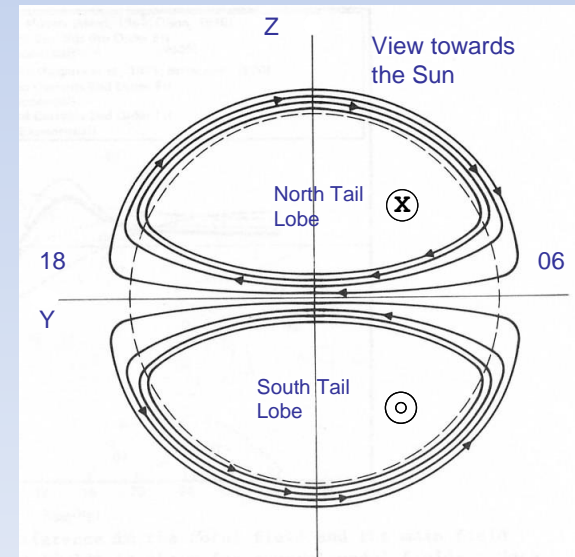

Fig. 2. Magnetic field data from ISEE 2 surrounding the ~0830 UT magnetopause crossing on May 31, 1978. From top to bottom the quantities plotted are the x, y, and z components (GSE coordinates) of the field and the total field magnitude.

crossing of the magnetopause



# Field aligned currents/1908

see lecture of Prof. Kikuchi

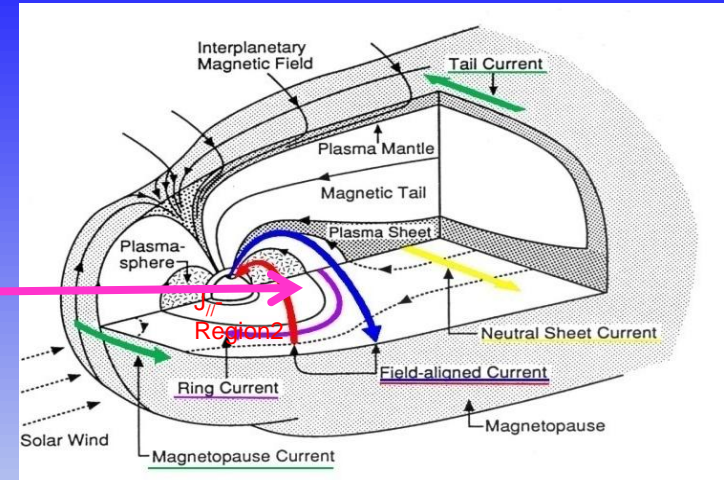
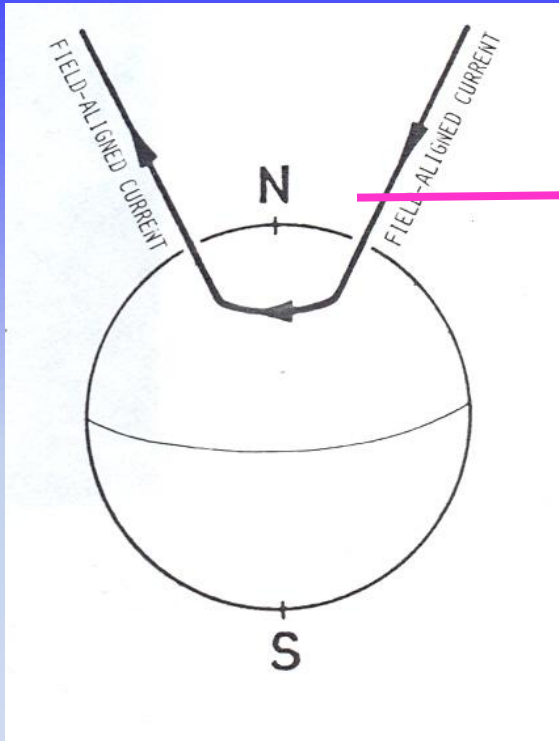

**Birkeland, 1908**

$$\nabla \cdot \vec{j} = \nabla_{\perp} \cdot \vec{j}_{\perp} + \nabla_{\parallel} j_{\parallel} = 0$$

The closure of the magnetospheric current loops requires field aligned currents flowing into and out of the ionosphere. The origin of the field aligned currents is near the equatorial edge of the magnetopause (region1), in the plasma sheet where the ring current is divergent (region 2) and at the magnetopause at high latitudes in the dayside.

# **Courants électriques ionosphériques**



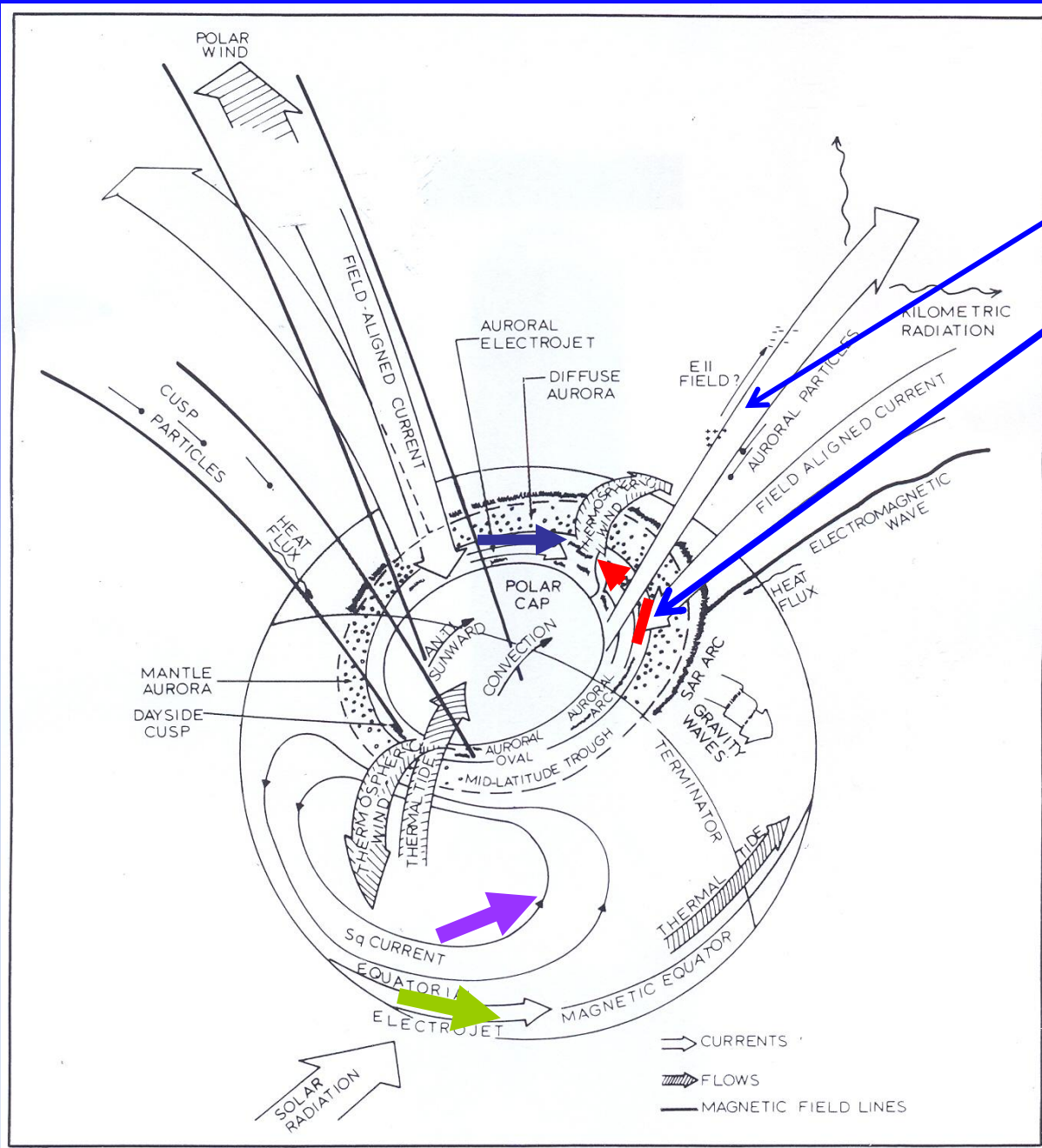

Field aligned current

Auroral electrojets

Precipitation of particles

Electric field

Auroral

Middle latitudes

Equatorial latitudes

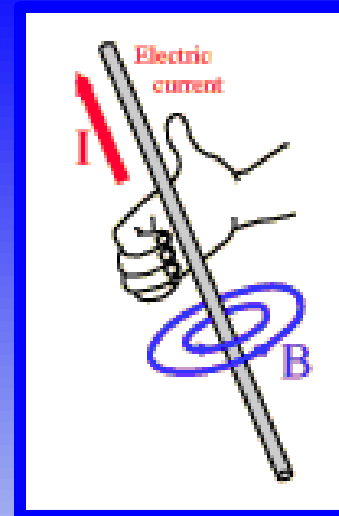
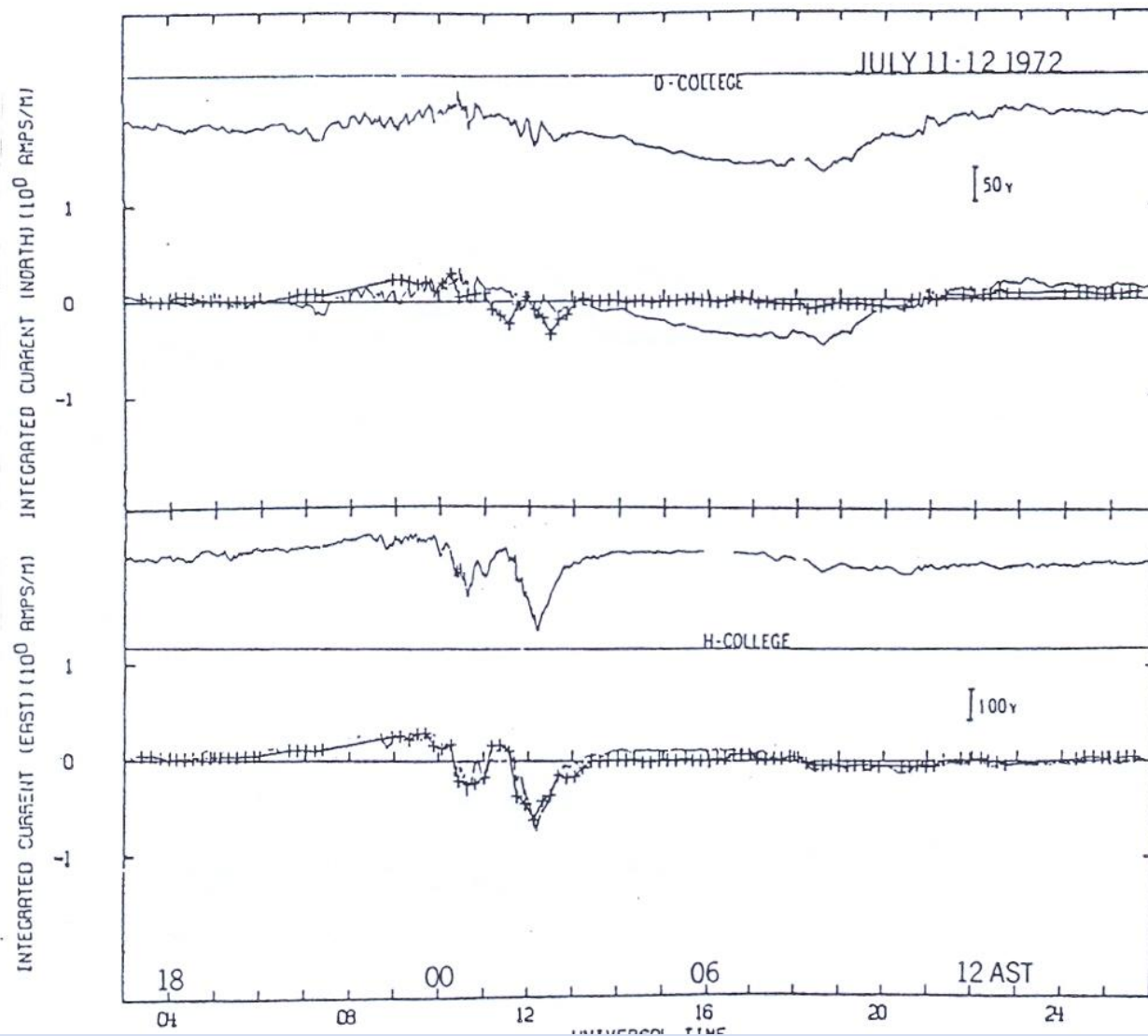

**H** : horizontal component  
**D** : declination

In situ measurements of electric height integrated electric current densities with the Chatanika incoherent scatter sounder and comparison with the variations of the Earth's magnetic field, on July, 11, 1972 [ after Brekke et al., 1974]. **AURORAL ZONE**

# In situ measurements of electric current densities at midlatitudes with the incoherent scatter sounder of Saint-Santin, Mazaudier, 1981

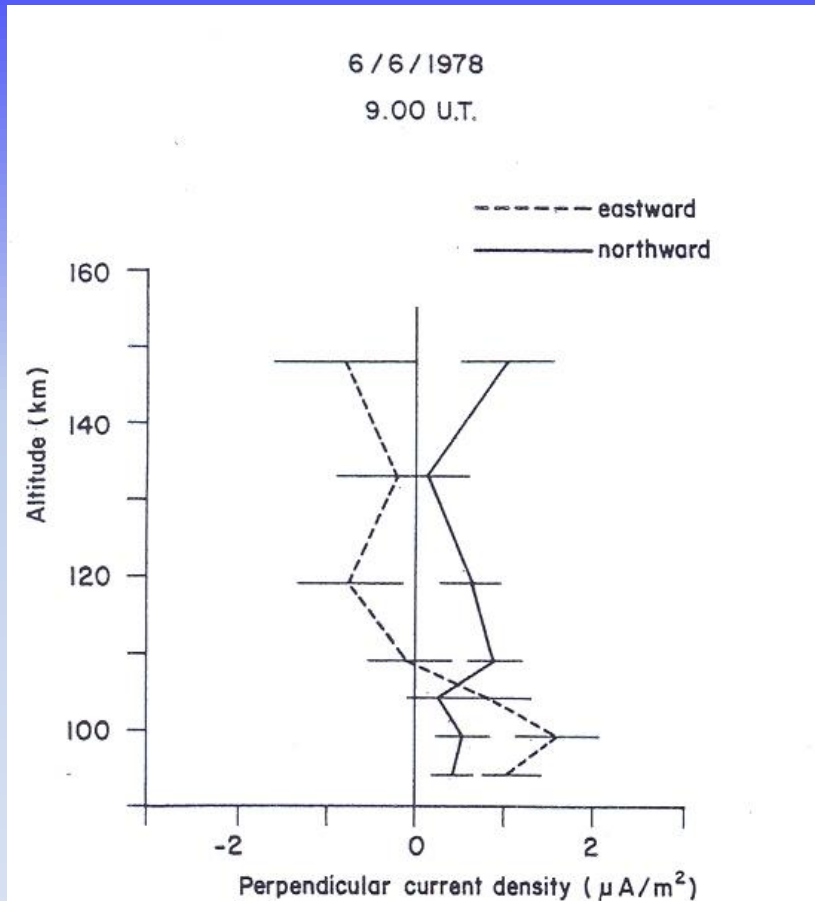

THERE ARE FEW MEASUREMENTS OF REAL ELECTRIC CURRENT

EQUIVALENT CURRENT SYSTEMS ARE DEDUCED FROM MAGNETIC DATA

Integrated electric current densities :  $\text{Amp}/\text{km} = \text{nT}$

**$\mathbf{J} = \sigma(\mathbf{E} + \mathbf{V} \times \mathbf{B})$  : Loi d'ohm ionosphérique**

# Exercice: Use of the SPIDR

## Space Physics Interactive Data Ressource

**Space Physics Interactive Data Resource**

**SPIDR Home**

National Geophysical Data Center (NGDC)  
NOAA Satellite and Information Service [privacy policy](#)

Data Access Steps >>>> **(1) Time Interval & Sampling** (2) Datasets (3) Data Basket

Home Tools and Guides Metadata Dashboard Publications SW Effects User Profile

**Controls**

User Status

Status **Guest**

Username

Password

Login

[Forgot your password ?](#)

[Want to contact us ?](#)

Registered users can save their requests in user basket. The registration is free, and we will use your user profile data only for usage statistics.

[Register >>](#)

**Data Access Steps**

**(1) Time Interval & Sampling**

Set a time interval using the 'Set Time Interval' link below before downloading a dataset!

**Select Data from the Archive** [-]

The Space Physics Interactive Data Resource (SPIDR) is designed to allow a solar terrestrial physics customer to intelligently access and manage historical space physics data for integration with environment models and space weather forecasts. SPIDR is a distributed network of synchronous databases and 100% Java middle-ware servers accessed via the World Wide Web.

**All datasets**

**Geomagnetic view** **Ionospheric view**

**SPIDR News**

- 2012-03-13T21:06:21  
[SPIDR 5.5.4.17 Released](#)  
Maintenance Release. Corrects some inconsistencies in the cataloging web service(s) relative to stations/datasets that have varying names across cadences. For example, g data uses 'AAA' for minute and hourly data, and 'AAA1' for yearly data. All cadences su the true station name now.
- 2012-01-26T20:12:22  
[SPIDR 5.5.4.14 Released](#)  
Maintenance Release: Includes some bug fixes for the RESTful API catalog service. A fraction of data sets were being omitted from the catalog service's XML output.
- 2011-10-05T22:12:26  
[SPIDR 5.5.4 Released](#)  
Feature Release: Includes new DMSP dataset and interface for data from the McMurdo ground station.

**Metadata Catalog**

**SPIDR Virtual Observatory**  
SPIDR Virtual Observatory includes inventory level XML metadata for SPIDR datasets stations, Wiki pages describing space physics data, and SPIDR system user, installatic administration guides

Help + Info  
News about the SPIDR network and databases  
[Usage Information](#) (4)  
Wiki section describing SPIDR datasets, parameters, units of measure, formats

Find space physics resources based on metadata



# OUTLINES

- \*Sun Earth System : a global electromagnetic complex system
- \*Dynamo process and large scale dynamos
- \*Electric currents associated to the different dynamos
- \*Magnetic field to approach electric currents
- \*Magnetic indices

## 4 DYNAMOS IN

### SUN

poloidal /toroidal

### MAGNETOSPHERE

Solar wind

IMF

### IONOSPHERE

Earth's magnetic field

Neutral wind

### EARTH

Motions of the core

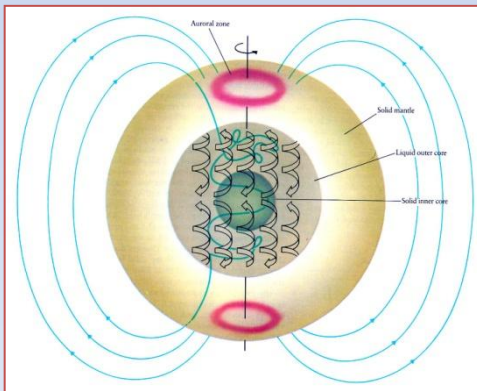

## CURRENT SYSTEMS

### MAGNETOSPHERE

Chapman Ferraro

Ring current

Tail current

### FIELD ALIGNED

### IONOSPHERE

Auroral electrojets

Midlatitude currents

Equatorial electrojet

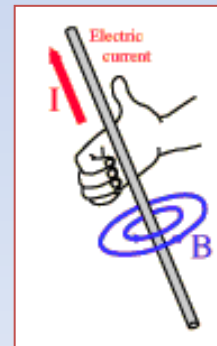

## EARTH'S MAGNETIC FIELD -> Transient variations

Indices -> disturbances

Dst

Aa, Kp, Ap

Km, Am

AU, AL

Equivalent currents

DP1, DP2

Ddyn

$S_R <S_q>, S_q^P$

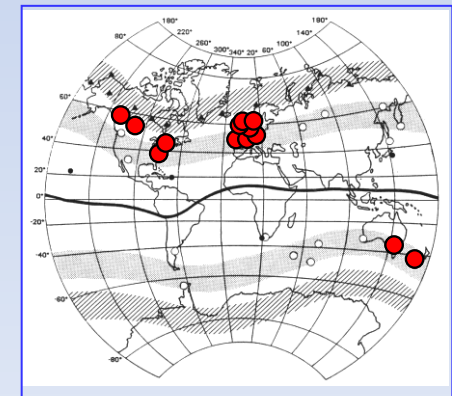



There are very few measurements of electric currents and many measurements of magnetic fields

We will use the magnetic data to approach the electric currents

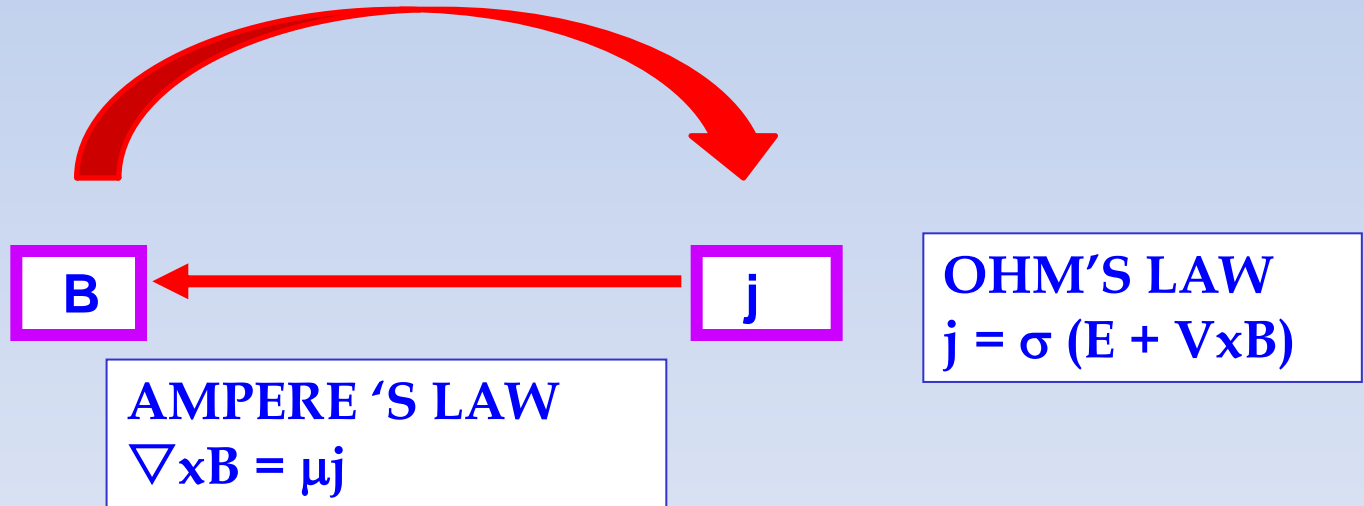
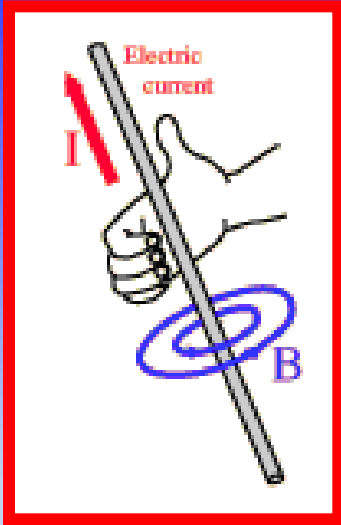

$$B = B_p + B_a + B_e + B_i$$

**$B_p$  = main field**

**(30000-60000nT)**

**$B_a$  = magnetization of the rocks in the  
Lithosphere**

**(~ 10-20 nT)**

**$B_e$  = external field related to ionosphere and  
magnetosphere**

**(10nT to 2000nT)**

**$B_i$  = induced field generated by the external field  
 $B_e$  , (Kamide and Brekke, 1975)**

**(% of  $B_e$ )**

**The main field changes very slowly :  
secular variation**

**The aimantation field is constant**



**Transient variations of the earth's  
magnetic field are due to external  
electric currents and are indirectly a  
measure of these currents**

- **Transient variations of the Earth's magnetic field :**

$$\Delta \mathbf{B} = \mathbf{B}_e + \mathbf{B}_i$$

$$\Delta \mathbf{B} = \mathbf{S}_R + \mathbf{D}$$

**Solar regular variation +**

**Disturbance**

$$\mathbf{S}_q = \langle \mathbf{S}_R \rangle$$

**average of the variation of the quiet days**

The disturbed D variation is the sum of the effects of the various electric current systems existing in the Earth's environment (Cole, 1966), Law Biot and Savart

$$D = DCF + DR + DT + DI + DG$$

DCF : magnetic disturbance due to the Chapman Ferraro current  
(~ qq nT to 30 nT)

DR : magnetic disturbance due to the ring current  
(~ qq nT to ~ 600nT)

DT : magnetic disturbance due to the Tail currents  
(~ qq nT to 20 nT)

DI : magnetic disturbance due to the ionospheric disturbed electric current (DP1, DP2, Ddyn)  
(~qq nT to 2000 nT)

DG : magnetic disturbance due to electric currents flowing in the ground related to external electric current systems (~30 % or more ) cause of power failure

# THE EARTH MAGNETIC FIELD

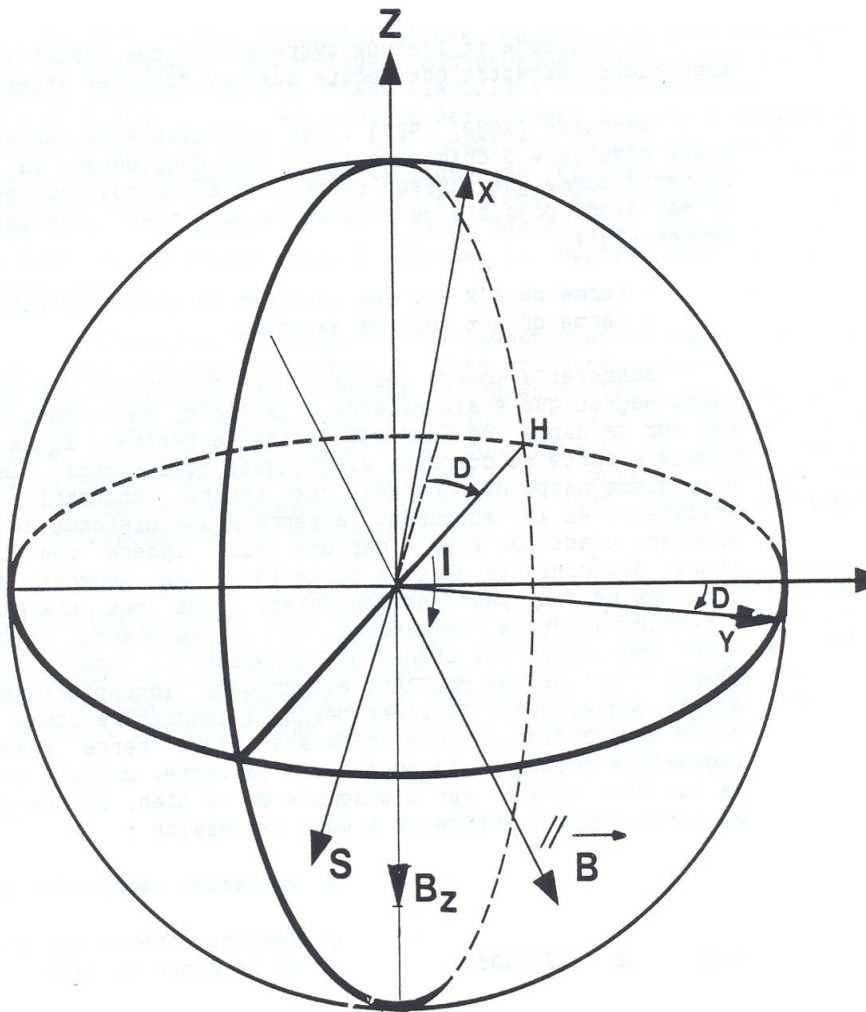

## Components of the Earth Magnetic field

**H** : horizontal component

**D** : declination

**Z**: vertical component

**I**: inclination

**X** : Northward component

**Y**: Eastward component

**Z**: Vertical component



# The earth's magnetic field integrated the effects of all current systems

Day to day variability of the Earth magnetic field

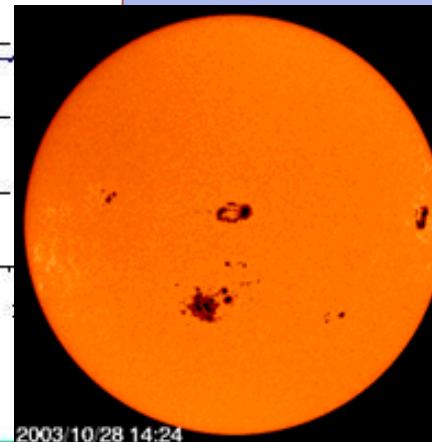
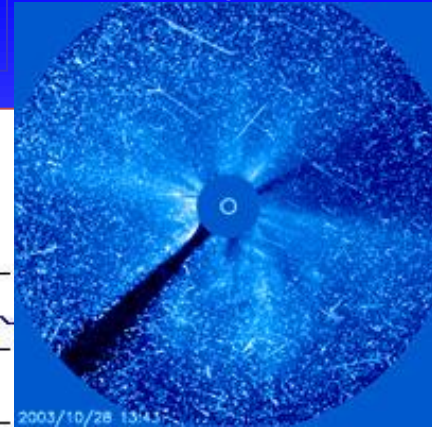
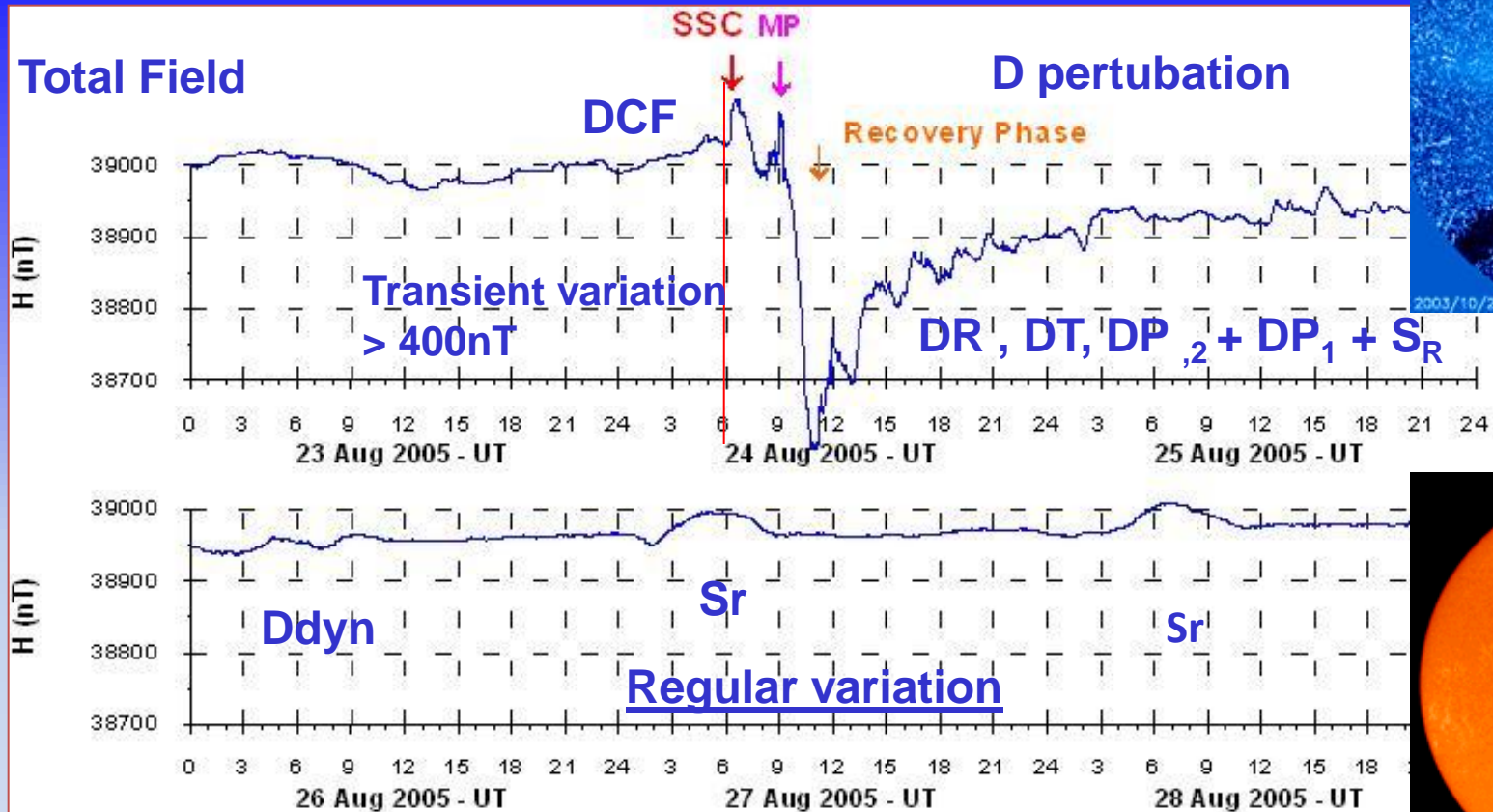

Time variation of the H-component observed at Phu Thuy (Hanoi – Vietnam) from 23<sup>th</sup> to 28<sup>th</sup> August 2005

# EQUIVALENT CURRENTS

# Equivalent current : principle

- We derive from the magnetic data 'an equivalent current system' which approach 'the real current system'
- The equivalent currents system is based on hypothesis concerning the geometry and some properties of the real currents. **These hypothesis simplify the reality.**
- Nevertheless the equivalent current systems help to organize the magnetic data and **give a first rough approximation of the real currents.**

# EQUIVALENT : Method

- We organize the magnetic data as follow:
- **1) latitude**
- Polar, auroral, middle and low latitudes
- **2) physical process**
- Events related to regular sun radiation or
- High speed solar wind streams
- CME etc....

Equivalent currents  
Sq and equatorial electrojet  
IONOSPHERIC DYNAMAMO



# Transient variations of the earth's magnetic field (time variations :seconde, minute, hour, day, season, year and solar cycle)

$$\Delta B = S_R + D$$

- $S_R$  : regular variation of the Earth's magnetic field
- $D$  : disturbance
- **$S_q$  -> mean of the regular variation of the earth's magnetic field  $\langle S_R \rangle$**



# IONOSPHERIC DYNAMO

UV et EUV radiations are at the origin of the Regular variation  $S_R$  of the earth magnetic field

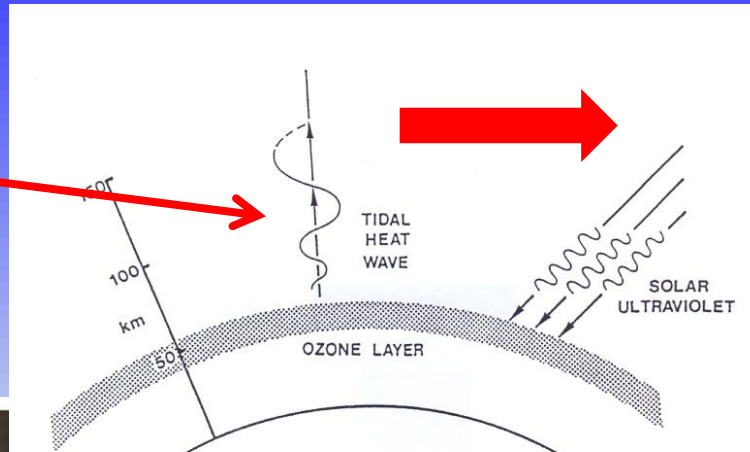
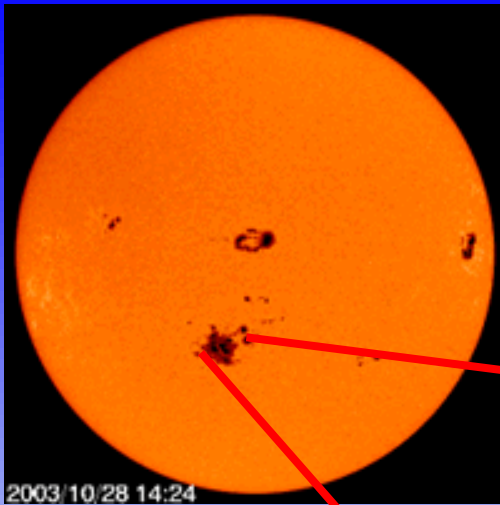

Electric currents  
Dynamo region  
 $90\text{km} < h < 150\text{km}$

## Motions of the atmosphere

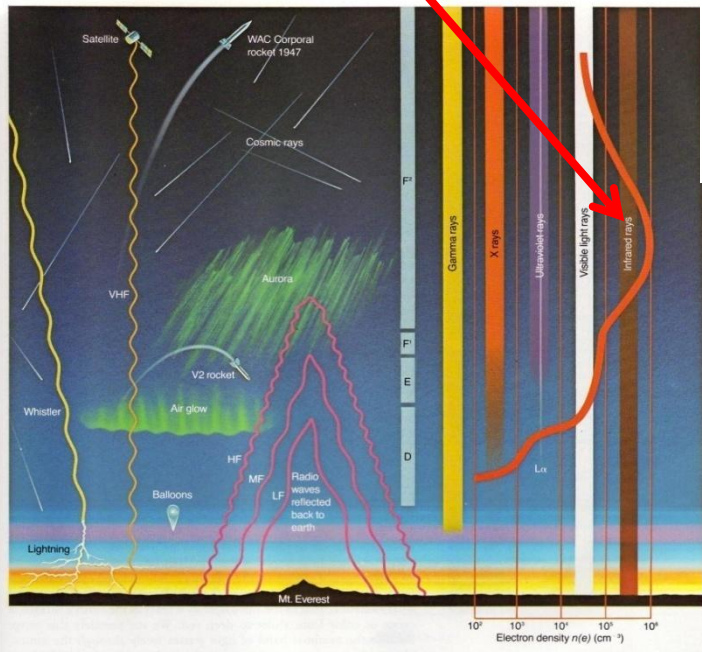

## Regular variation of the earth magnetic field Dayside

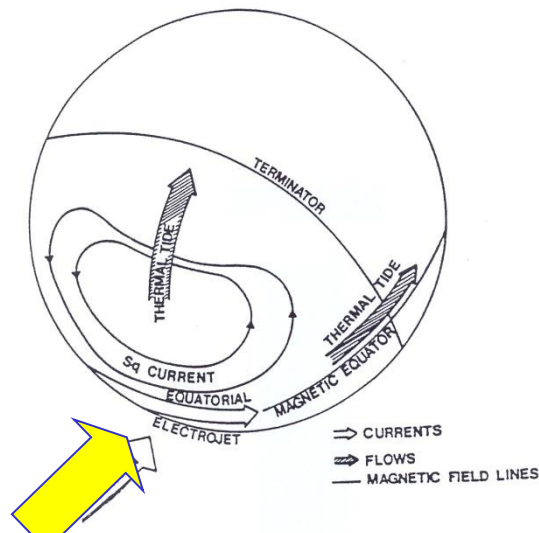

photoionisation create the ionosphere

# Infinite plane sheet above a plane earth: The closure of currents is assumed in each hemisphere separately

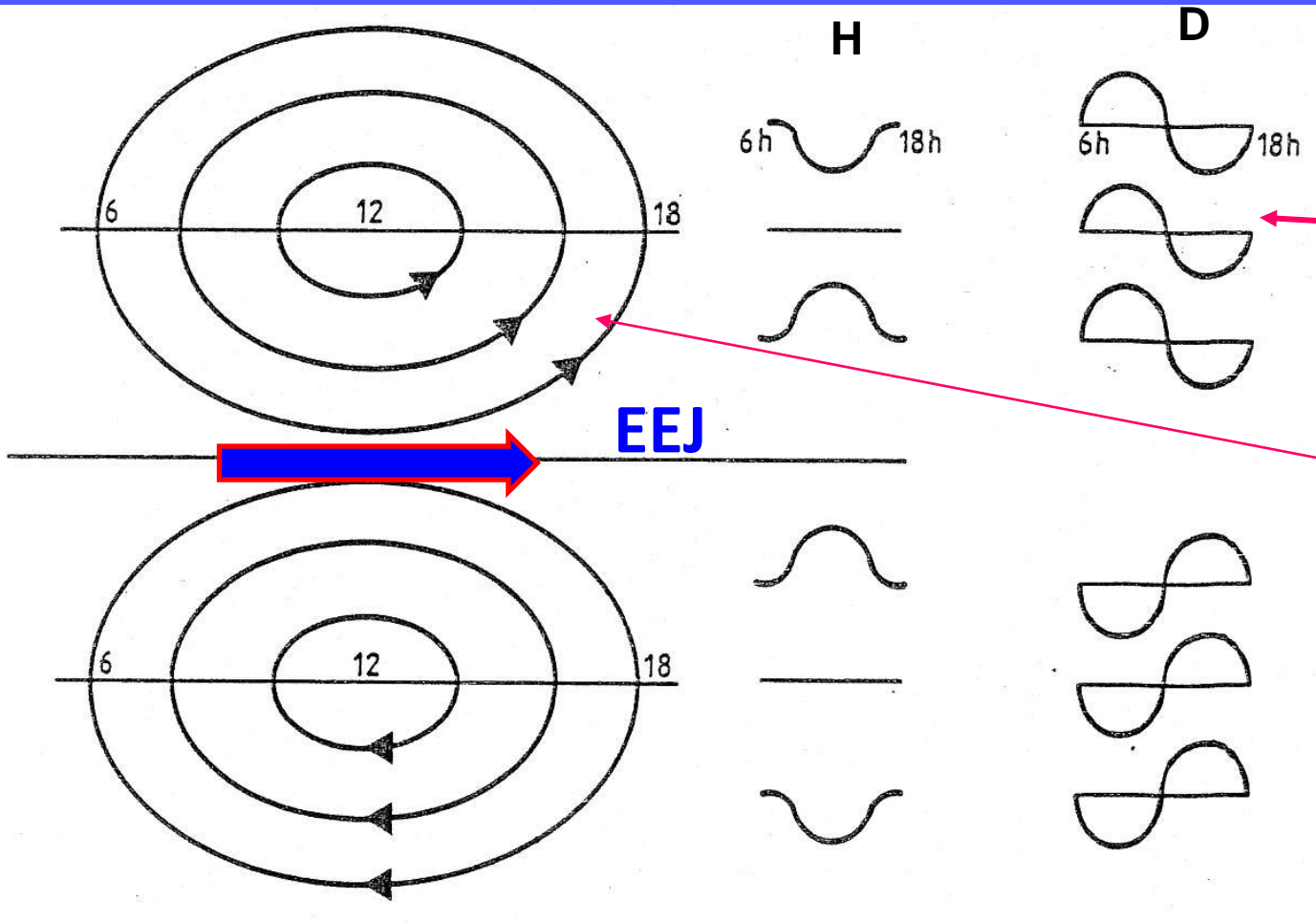

**FOCUS**

**LINES OF CURRENT**

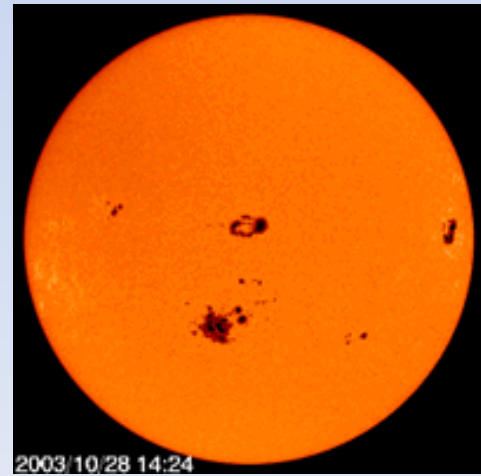

Equivalent current  $Sq/S_R$  [(Amory-Mazaudier ,1983)]

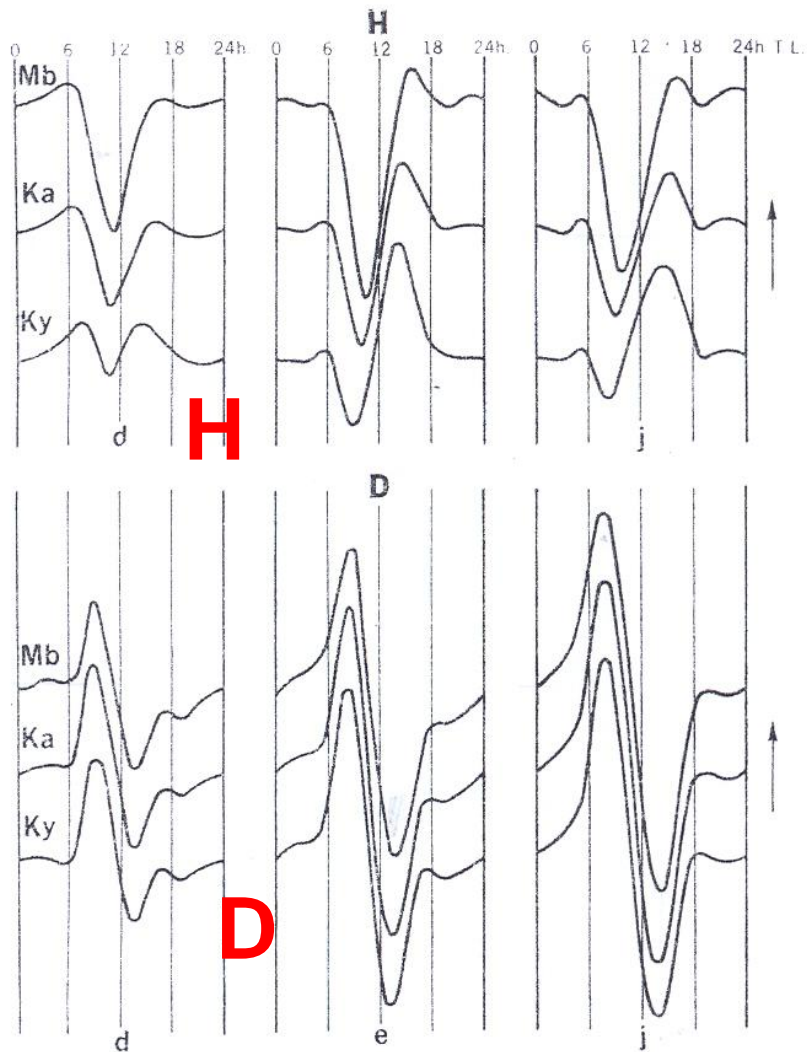

FIG. 20. — Courbes Sq de H et D pour les 3 saisons (*d* : solstice de décembre ; *e* : équinoxe ; *j* : solstice de juin) des années 1958-1959 à Memambetsu (Mb), Kakioka (Ka) et Kanoya (Ky). Échelle de 2 gammas/heure.

## Sq variations of the H and D component

3 stations in the Northern Hemisphere  
 Memambetsu (Mb),  
 Kanoya (Ky),  
 Kakioka (Ka).

**By the past**

**→ 3 magnetic seasons**

**Winter : d,**

**Equinox : e**

**Spring : j**

**TO CHANGE**

Diurnal variation  $Sq/S_R$

Seasonal variation  $Sq/S_R$

Annual variation :  $Sq/S_R$

Solar cycle variation  $Sq/S_R$

Disturbance D

# Seasonal mean diurnal variation of the X-component at Phu Thuy

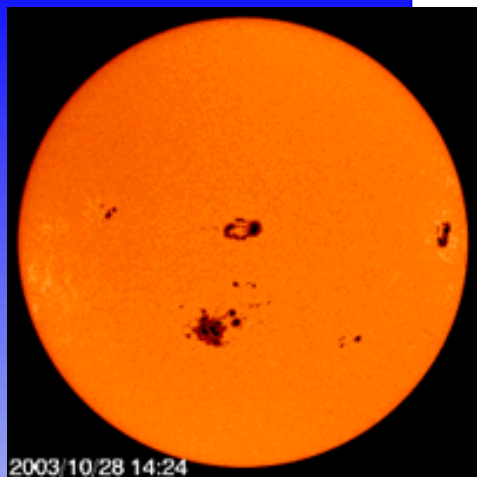

**SPRING**

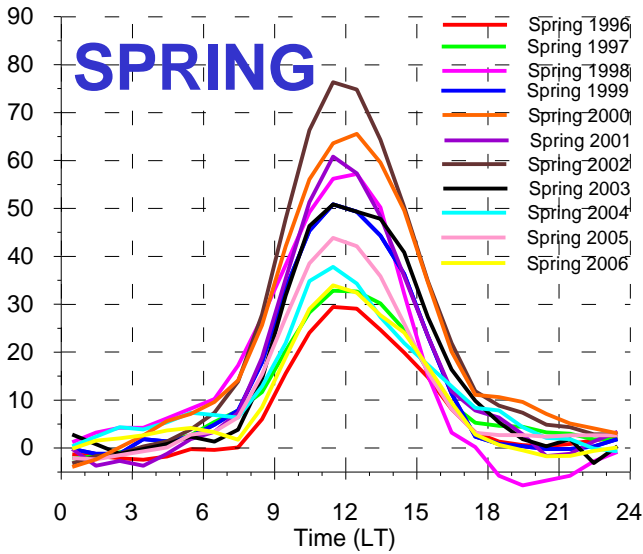

**SUMMER**

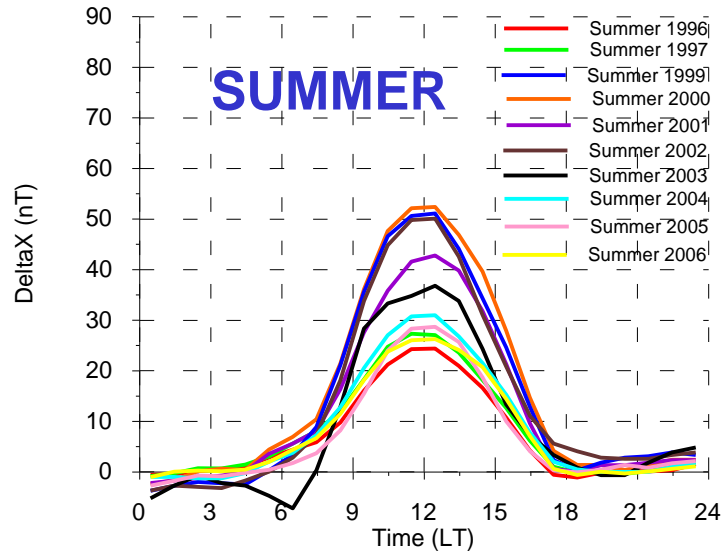

**AUTUMN**

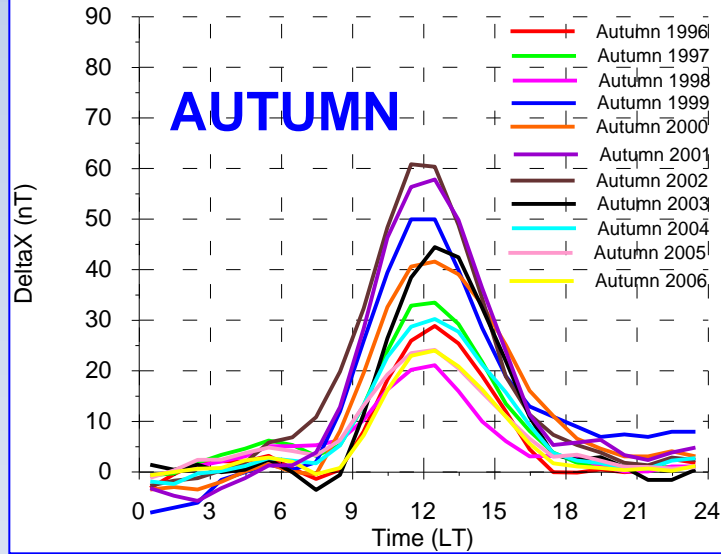

**WINTER**

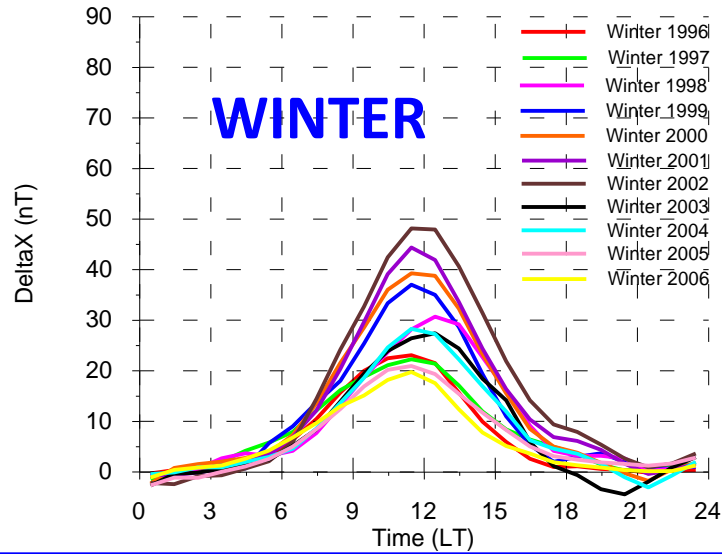



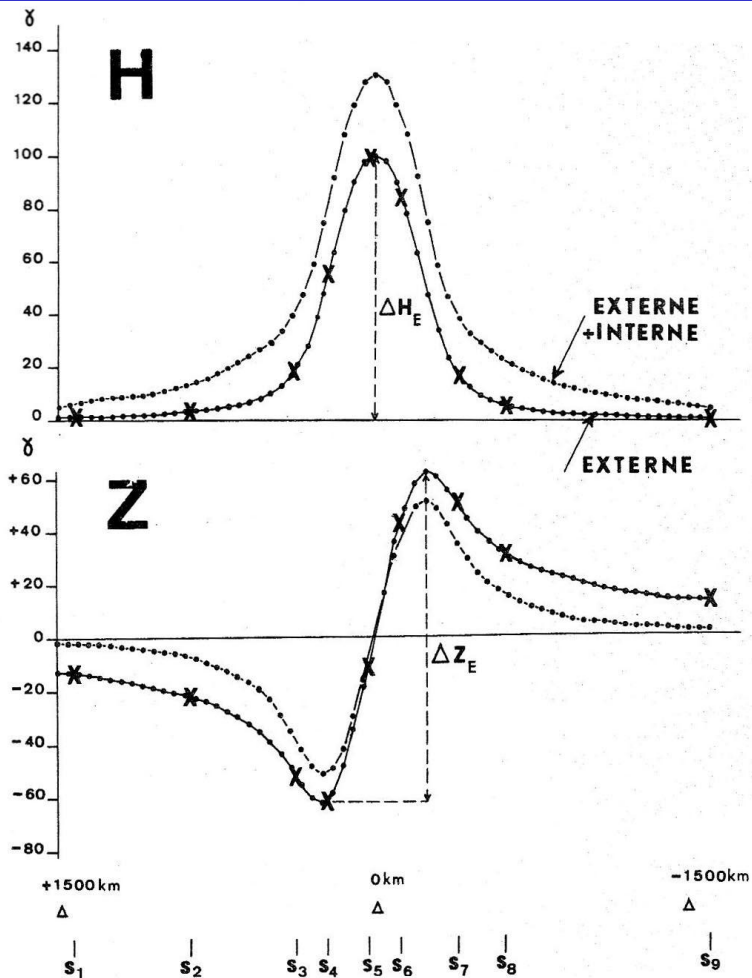

This figure from Fambitakoye (1973) present the latitudinal variations of the H et Z components under a ribbon of current. The H component is maximum at the equator and diminish with the distance to the equator. The Z component is zero at the equator and presents two maximum corresponding to the half height of the H component. The induced current is very weak.

$$B_e + (B_i \sim 0)$$

induction

External source



$$I(x) = I_0 \left[ 1 - \frac{(x-c)^2}{a^2} \right]^2$$

## Model of a ribbon of current

Where  $I_0$  is the current intensity at the centre  $c$  of the ribbon whose halfwidth is  $a$  and length is infinite. The ribbon is assumed to be infinitely thin, and located at a height of 105 km.

Contre-electrojet  
Gouin and Mayaud, 1967

IONOSPHERIC DYNAMO

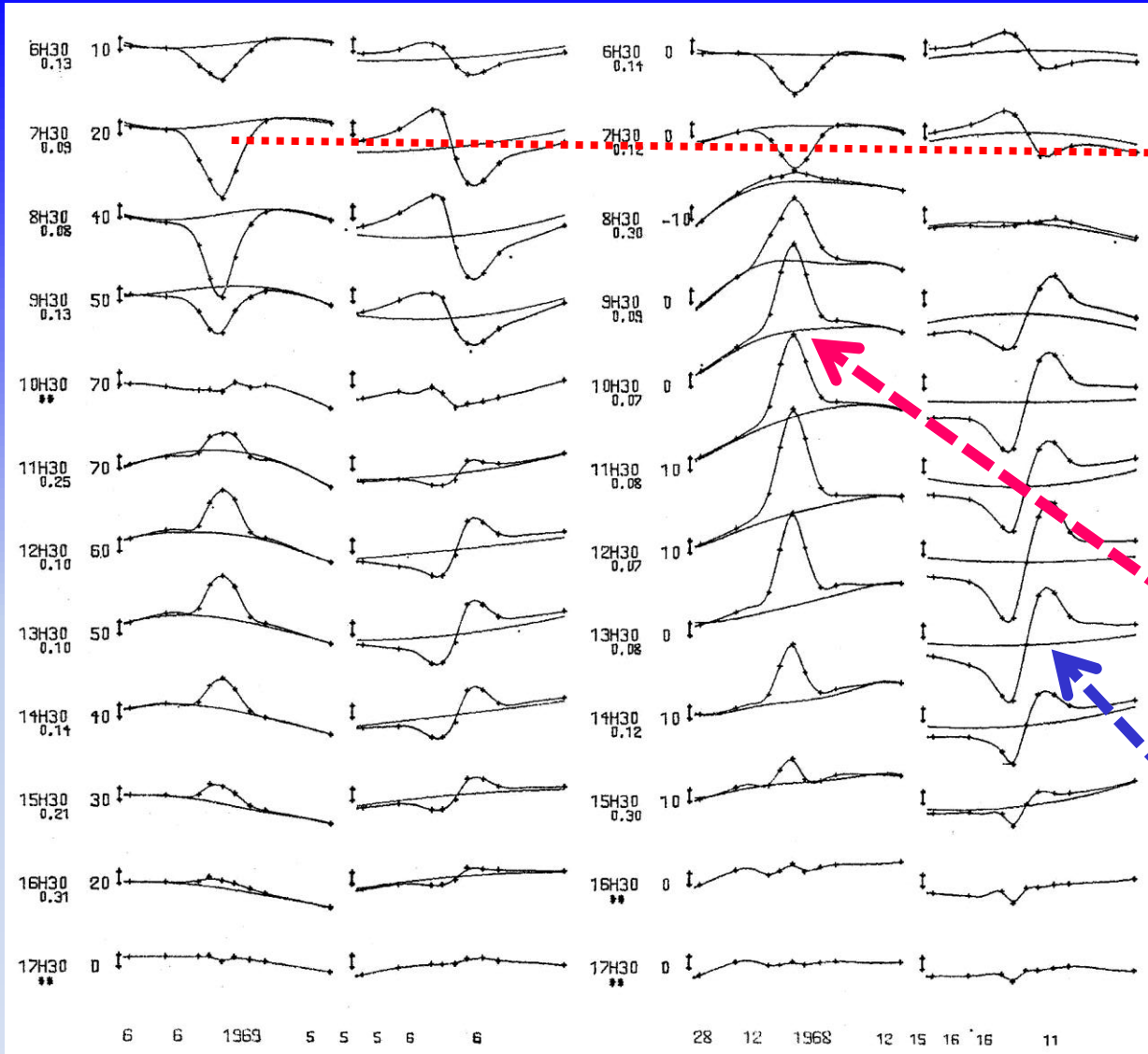

6 juin 1966

12 décembre 1968

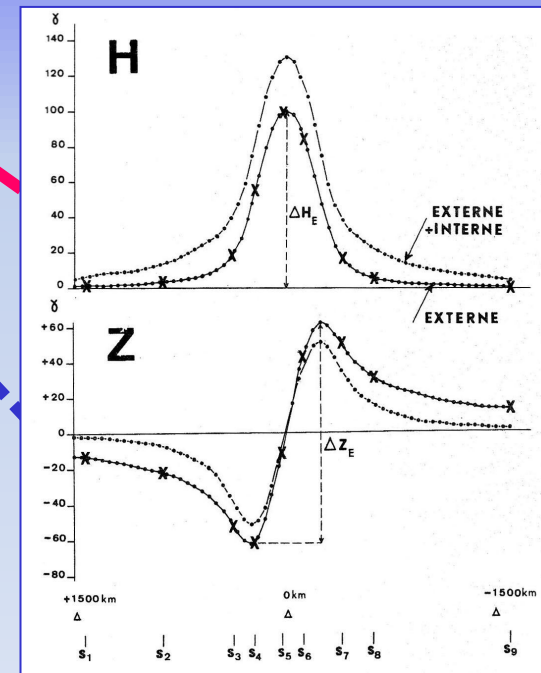

Latitudinal variation of the earth's magnetic field at equator  
[after Fambitakoye, 1975]



$$\Delta B = S_R + D$$

- $S_R$  : regular variation of the Earth's magnetic field
- **D : Disturbance**

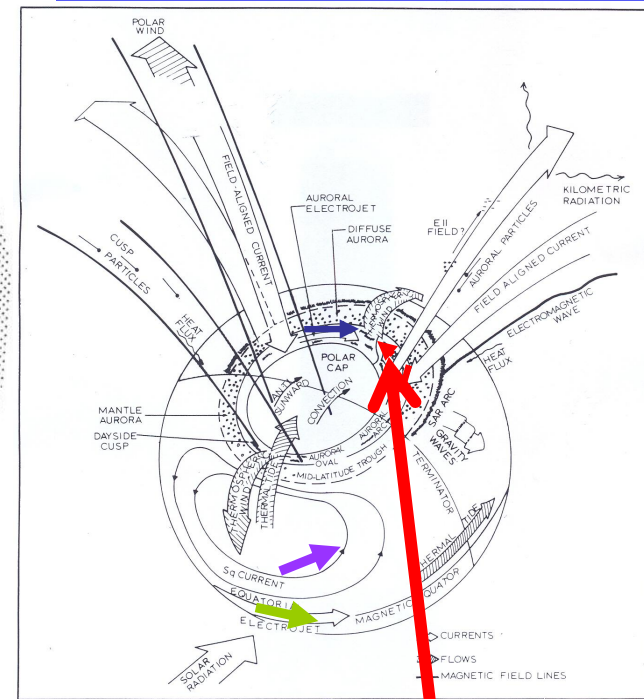
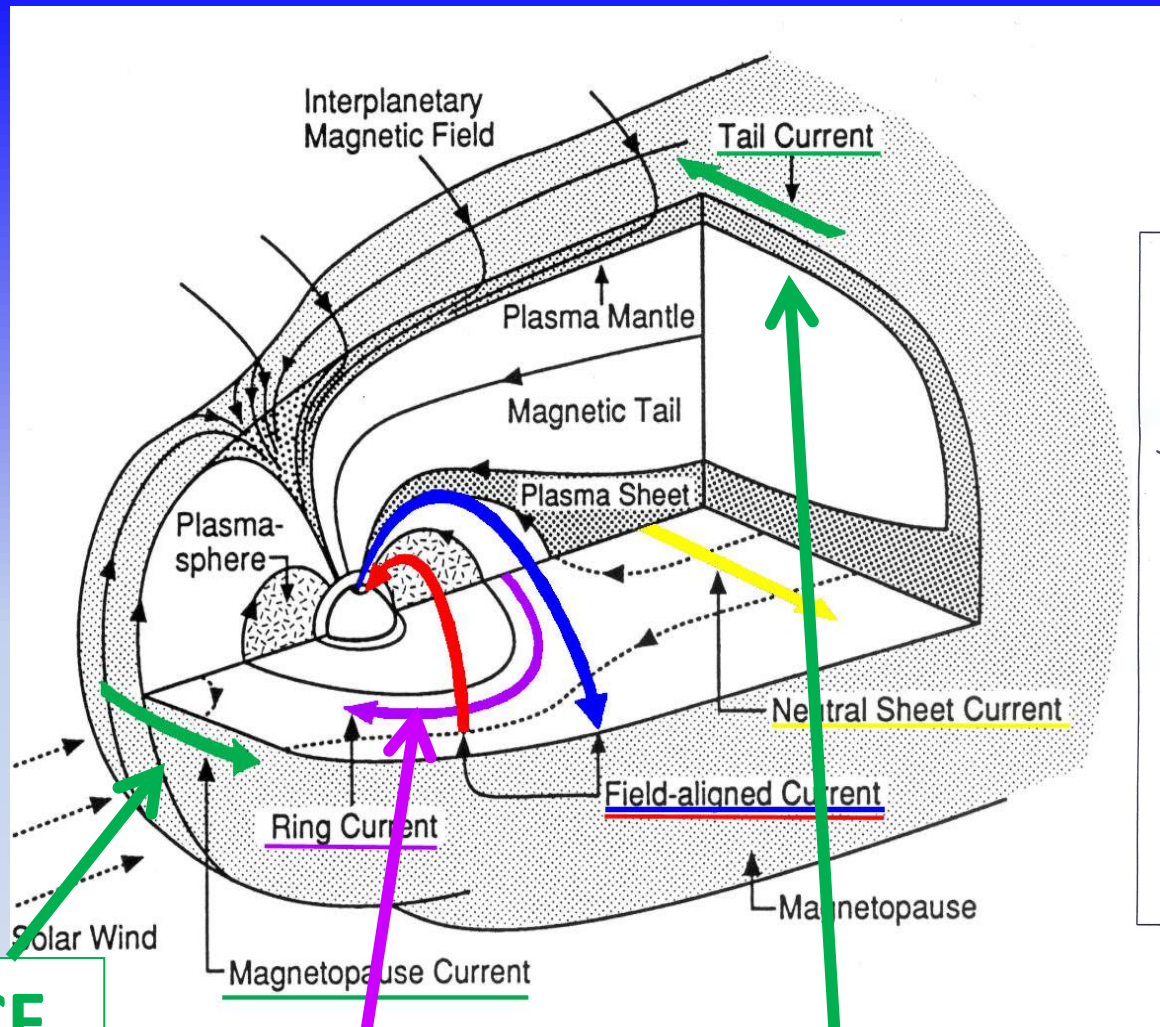

DCF

DR

DT

DI

# Magnetic Disturbance due to Electric current disturbance in the Ionosphere

- The disturbance is composed of different parts associated to different physical process
  - **$DI = DP1 + DP2 + Ddyn$**
- DP1 : polar magnetic disturbance associated to substorm (Rostoker 1967)
- DP2 : magnetic disturbance associated to the magnetospheric convection electric field (Nishida 1968)
- Ddyn : magnetic disturbance associated to Joule heating (Blanc and Richmond, 1980; Le Huy and Amory-Mazaudier, 2005).

# Equivalent current: DP2

see lecture of Prof. Kikuchi

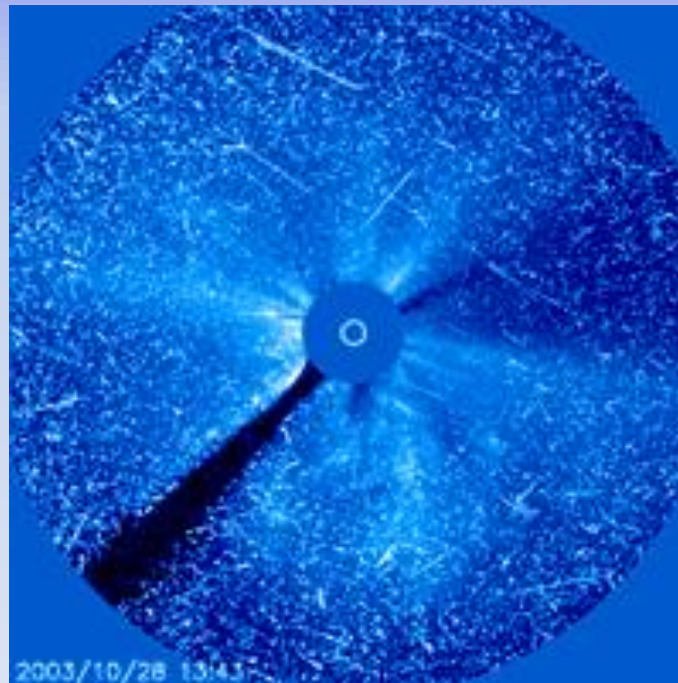

# EQUIVALENT CURRENT SYSTEM DP2

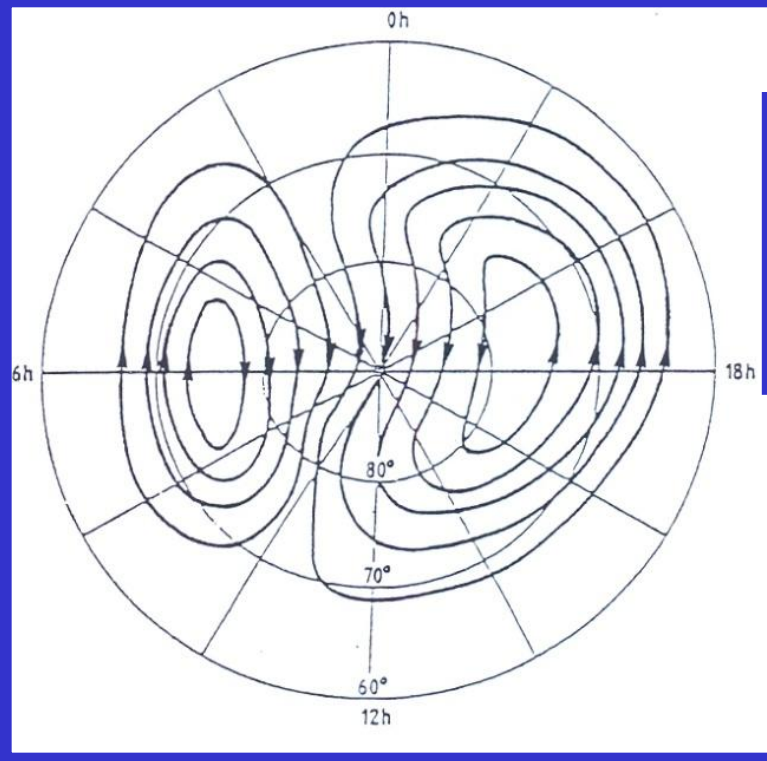

$S_q^P$  Nagata and Kokubun, 1962  
Rep. Ionoph Space Japan, 16, 150  
This current system is confined at high latitudes during quiet magnetic periods

$DP_2$ , Nishida, 1968, JGR, 73, 5549  
Current system extending toward latitudes during magnetic disturbed periods  
[Nishida et al., 1966]

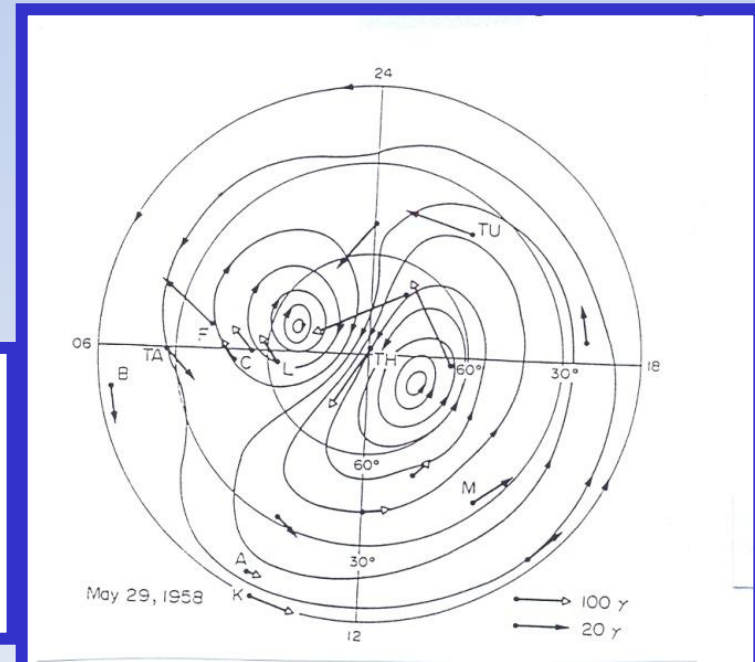



# Penetration of the magnetospheric convection electric field to low latitudes, Kikuchi et al., 2000, JGR, Vol 105, N° A10, 23251-23261

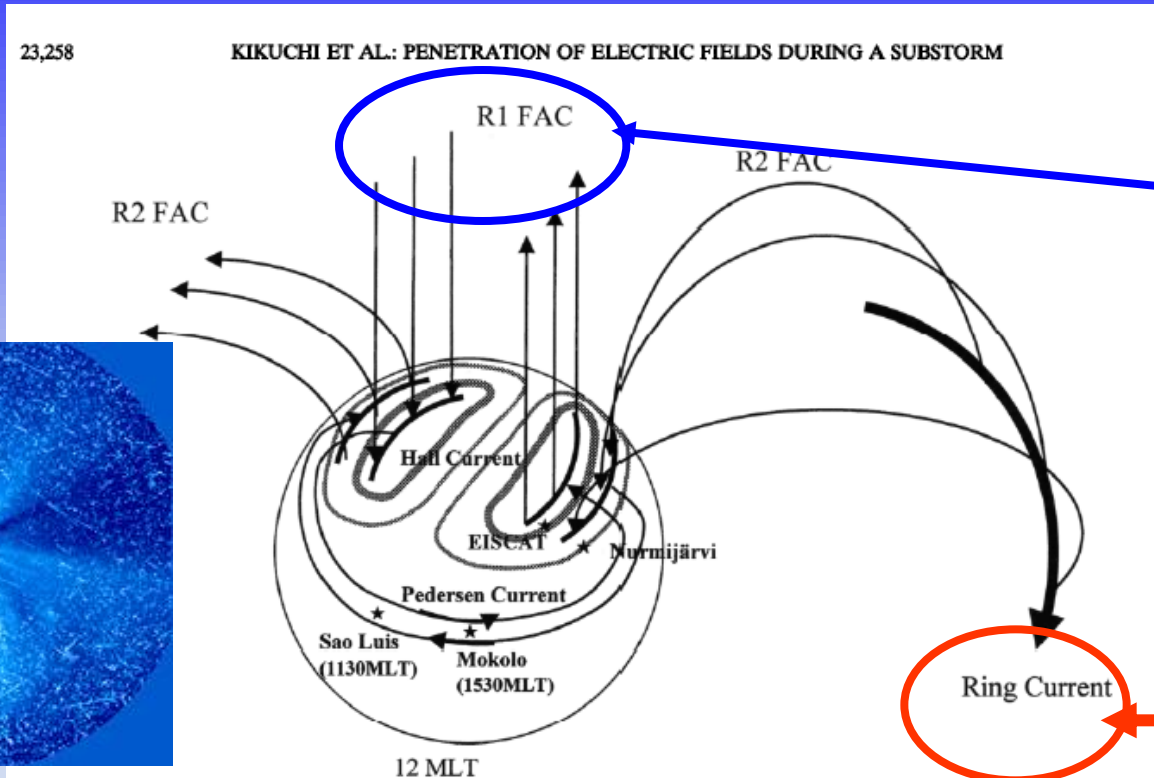

Direct process  
DDP

Loaded driven  
process/RC

Shield effect  
Shielding  
Overshielding

**Figure 7.** Schematic picture of Region 1 (R1) and Region 2 (R2) field-aligned currents (FACs) with locations of EISCAT, Nurmijärvi, and equatorial (Sao Luis and Mokolo) stations. The dominant electric field associated with R1 FACs is northward in the high-latitude afternoon sector and eastward at the daytime dip equator. The R2 FACs enhance the northward electric field at EISCAT but reduce this component at the Nurmijärvi and equatorial stations. The electric fields drive ionospheric Hall currents at high latitudes and Pedersen currents at the dip equator. The Hall currents are closed circuits in the ionosphere, while the Pedersen currents are connected to the R1 and R2 FACs. The magnetic local time of the equatorial stations corresponds to the peak of the negative bay at 1440 UT.

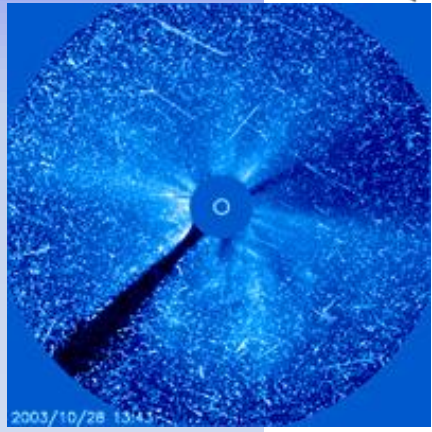

23,258

KIKUCHI ET AL.: PENETRATION OF ELECTRIC FIELDS DURING A SUBSTORM

2003/10/28 13:43



# Electrodynamic coupling between high and low latitudes on May, 27, 1993 Kobéa et al. 2000, JGR, Vol 105, A10, 22979-22989

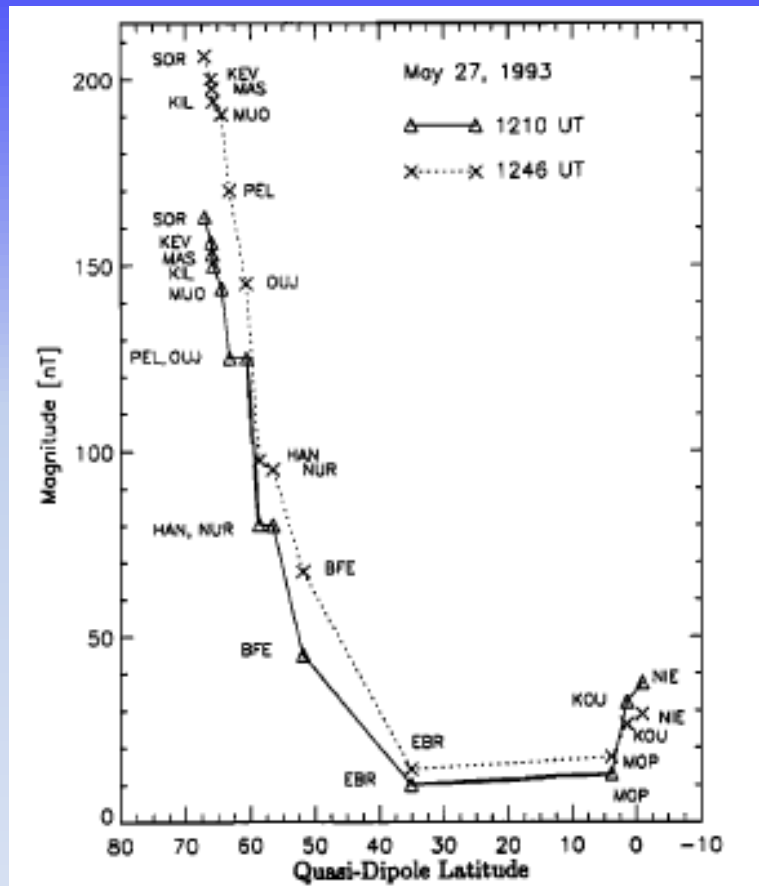

Figure 4. Latitudinal profile of the fluctuations at 1210 and 1246 UT extending to the equator, in the longitudinal sector ranging from 65° to 120° magnetic longitude including IMAGE and the West African network.

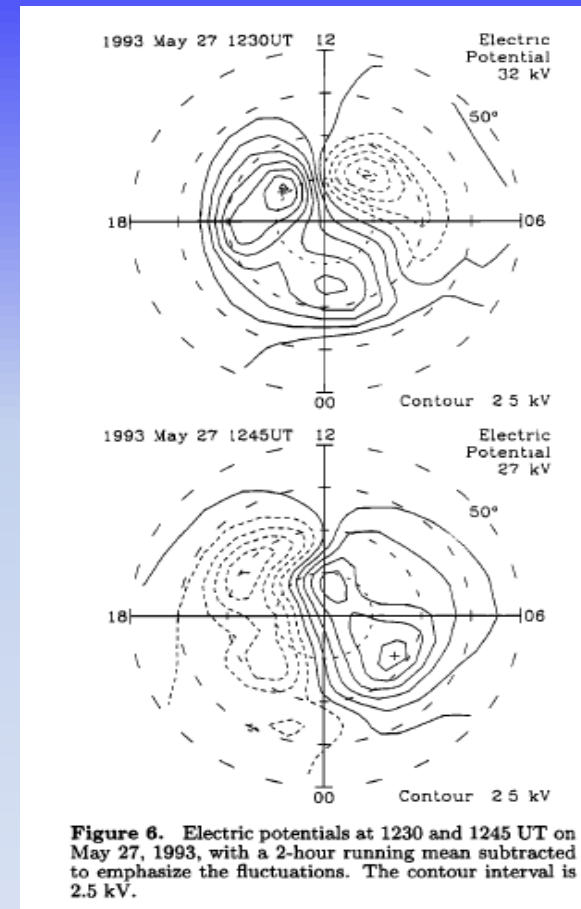

Figure 6. Electric potentials at 1230 and 1245 UT on May 27, 1993, with a 2-hour running mean subtracted to emphasize the fluctuations. The contour interval is 2.5 kV.

Richmond and Kamide, 1988 AMIE  
JGR vol 83 n°A6, 5741-5759

# EQUIVALENT CURRENT DP1 - SUBSTORM

**Equivalent current  $DP_1$   
On current cell on the  
nightside**

**Substorm model  
Fukushima and Kamide, 1973**

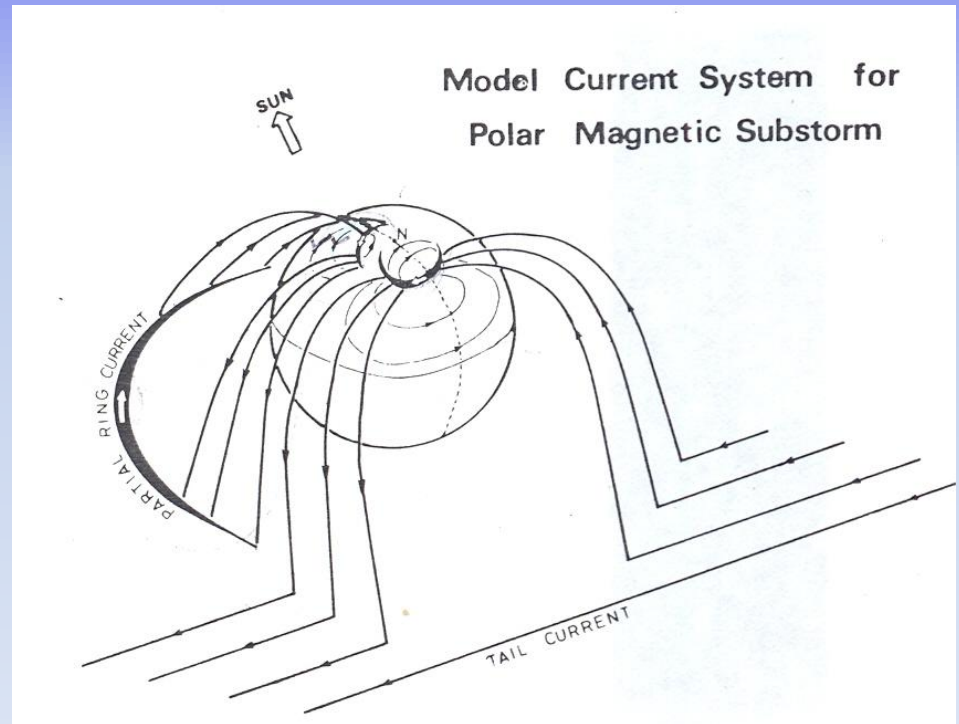
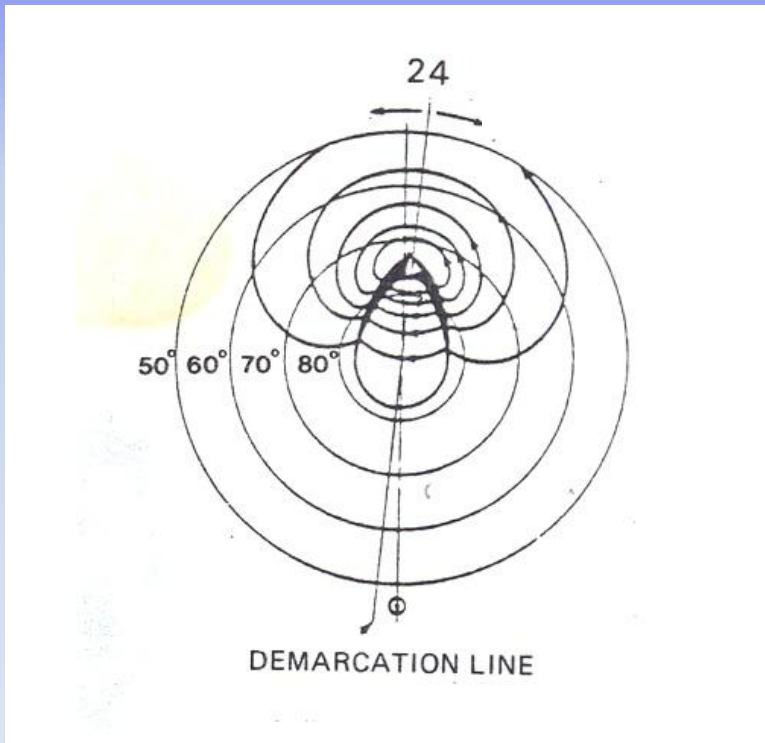

**Rostoker, 1967**

**Equivalent current :  $D_{dyn}$**

# Ionospheric disturbance dynamo/secondary dynamo

JGR,85, 1669-1686, **1980** Blanc and Richmond

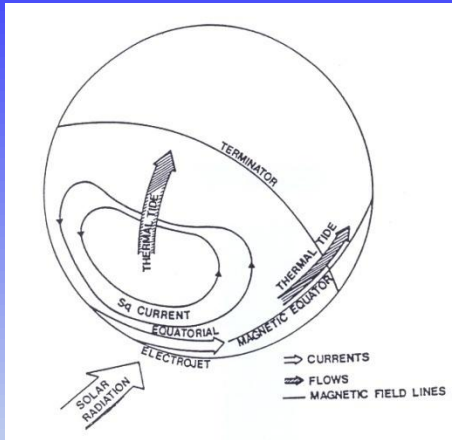

Regular wind

Mazaudier and Venkateswaran, **1990**  
Annales Geophysicae, 8, (7-8), 511-518

Disturbance Dynamo Model

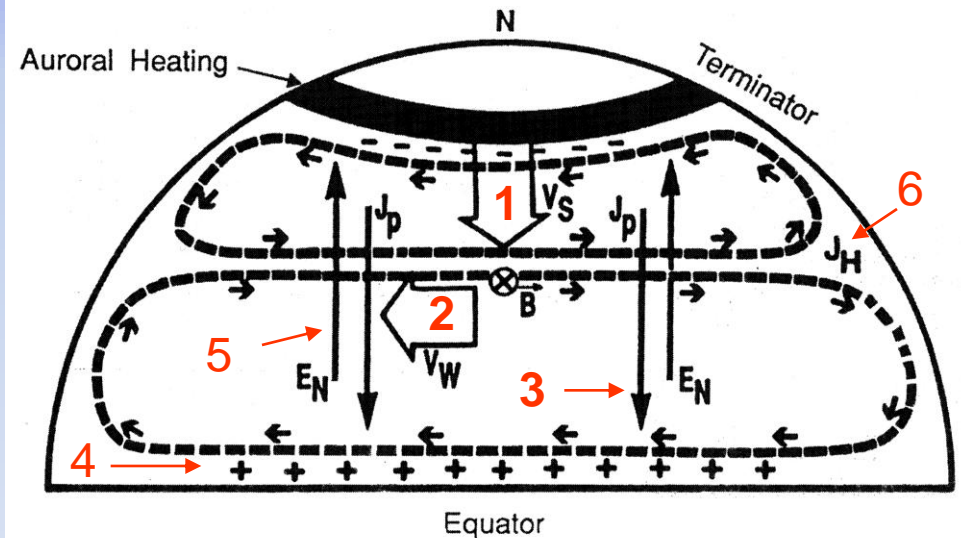

Storm wind

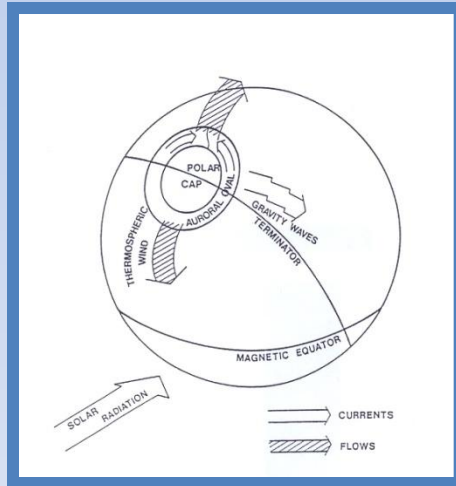

Richmond and Matshushita, JGR, **1975** vol 80, N°19, 2839-2850  
Thermospheric response to a magnetic storm

Ddyn

# Signature of the ionospheric disturbance dynamo: D<sub>dyn</sub>

Le Huy and Amory-Mazaudier, JGR, 2005

Blanc and Richmond, 1980

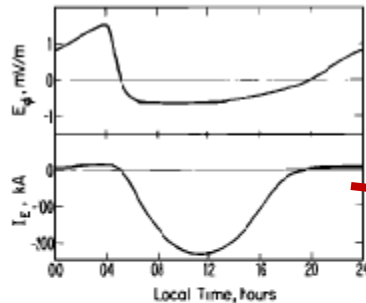

Fig. 9. Local time distributions of the equatorial electrojet parameters  $E_{\phi}$ , eastward electrostatic field, and  $I_E$ , total eastward current flow between  $+10^{\circ}$  and  $-10^{\circ}$  magnetic latitude. Both are basically reversed from their observed normal quiet-day variation.

## 2. Criteria for the Selection of Cases and Data Analysis

### 2.1. Criteria

[10] Our purpose being to study the sole ionospheric disturbance dynamo process, we must point out that only daytime signatures can be inferred from the data. Here are the criteria for the selection of the period of observation: (1) daytime period => to study the dynamo action in the E region, (2) period immediately after a storm => there is Joule heating in auroral regions during the period preceding our selected period, (3) no auroral electrojet => there is no penetration of the magnetospheric convection electric field during our selected period.

D<sub>dyn</sub>

$$D_{\text{dyn}} = \Delta H - S_R - DR$$

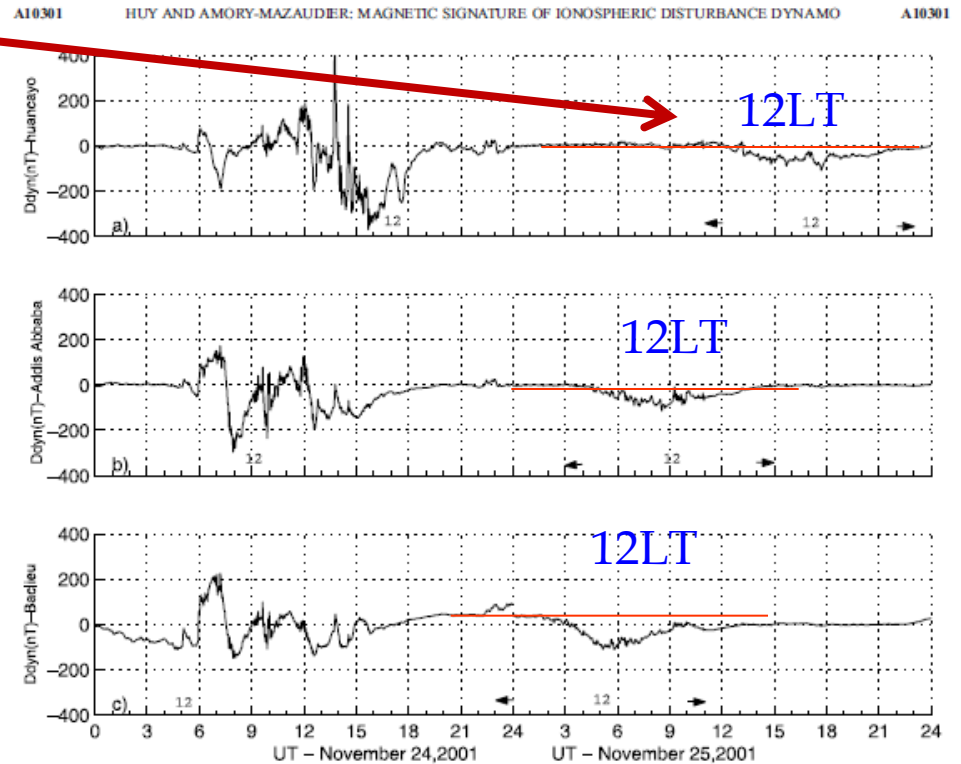
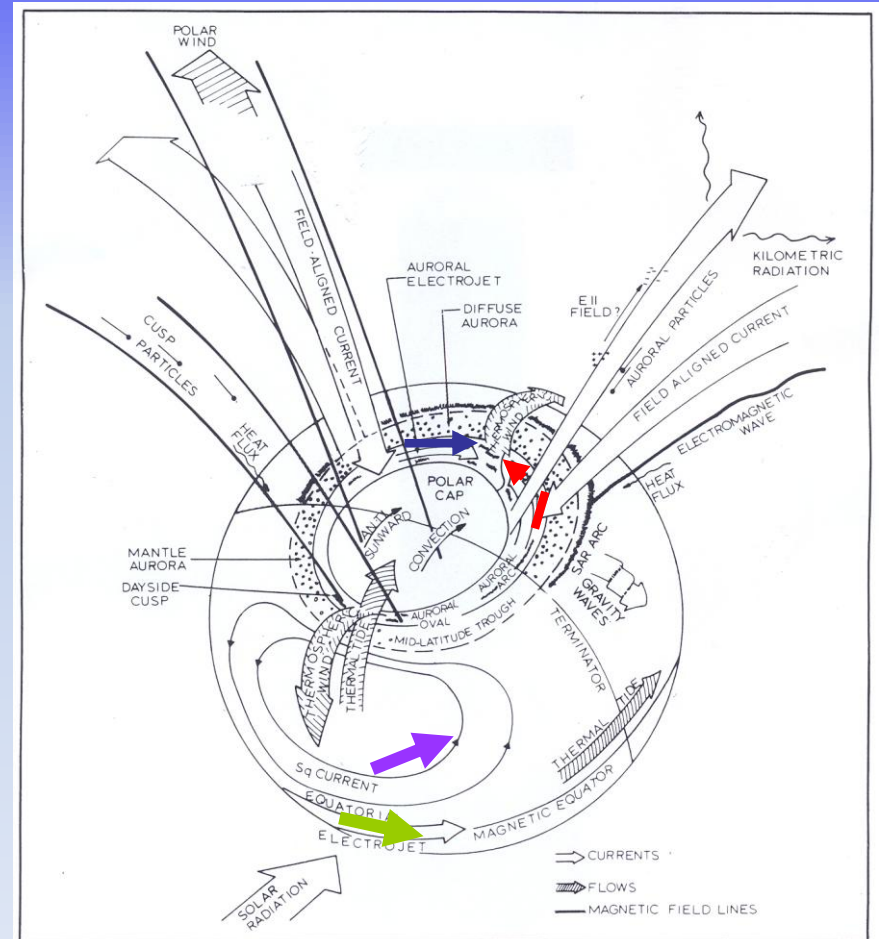
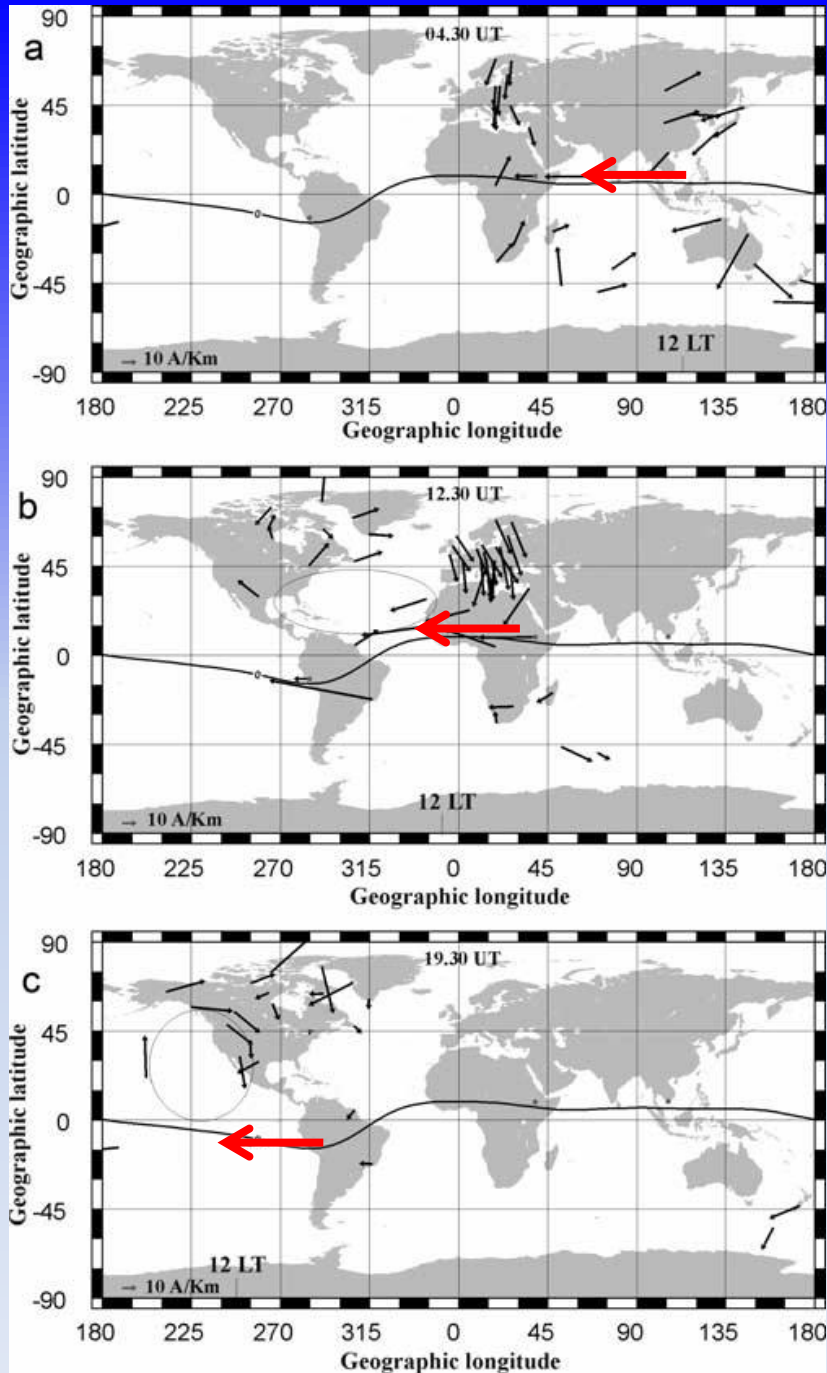

Figure 9. Same as Figure 4 for the sixth storm event on 24 and 25 November 2001.



# Dynamo Ionosphérique Perturbée

Le Huy et Amory-Mazaudier  
JGR, 2005 et JGR, 2008



## BASSES ET HAUTES LATITUDES

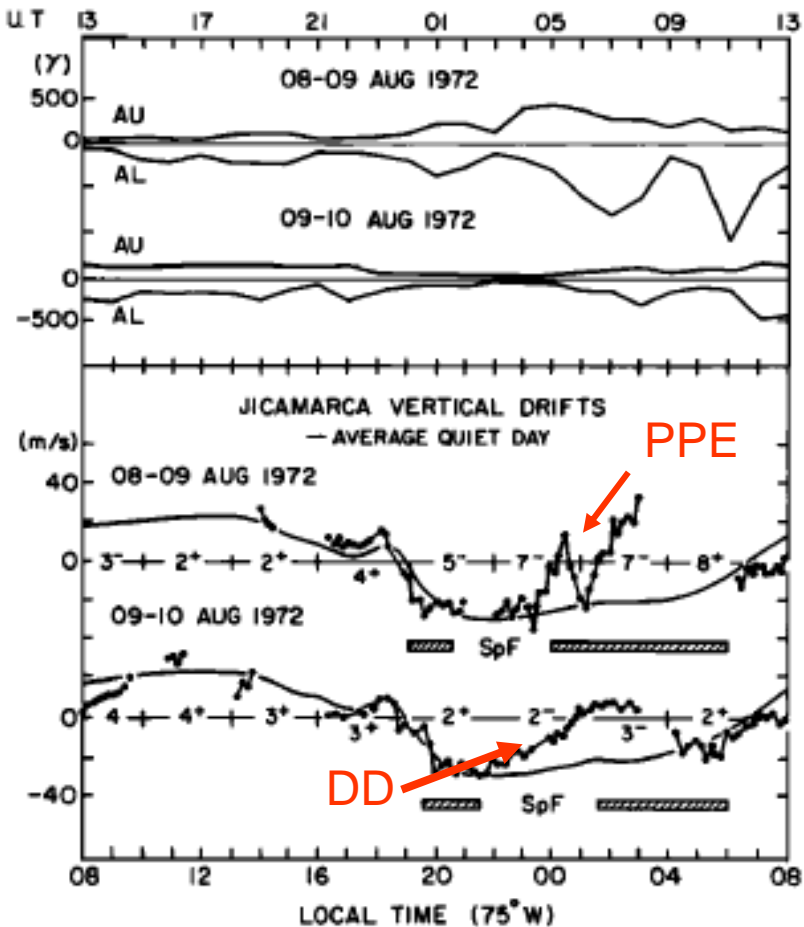

Figure 1. Auroral electrojet indices and F-region vertical drifts at Jicamarca on August 8-10, 1972. The solid curves in the lower panel show the average quiet time diurnal variation. Deviations from this pattern beginning at 2300 LT on August 8 are due to direct penetration effects, whereas the slower deviations starting at 2200 LT on August 9 are due to the disturbance dynamo.

Equatorial Disturbance  
Dynamo Electric Fields  
Fejer et al., 1983  
GRL, Vol 10, N°7, 537-540

Mayaud, JGR 1980  
Comment on the Ionospheric  
Disturbance dynamo

Blanc JGR 1983  
Magnetospheric convection  
Effects at midlatitudes  
1. Saint-Santin Observations  
Vol 88, P. 211

# Outlines

- Sun Earth System : a global electromagnetic complex system
- Dynamo process and large scale dynamos
- Electric currents associated to the different dynamos
- Magnetic field to approach electric currents
- Magnetic indices

# MAGNETIC indices

## WHY MAGNETIC INDICES ?

- **THE CONCEPT OF MAGNETIC INDICES**
  - K index,  $S_R$
- **USE OF MAGNETIC INDICES FOR GEOPHYSICS STUDIES**
- **Kp(ap)/ Km (am)**
  - to select quiet days
  - to approach solar wind components
- **Aa index**
  - signature of the 2 components of the solar magnetic field
  - long term variation of solar activity
  - physics of solar-geomagnetism activity
- **Storm Dst index**
- **Auroral indices AU and AL**

**WHY MAGNETIC INDICES ?**  
**TO APPROACH A COMPLEX REALITY**

# THE CONCEPT OF MAGNETIC INDICES

## K INDEX / $S_R$

- Derivation Meaning and Use of geomagnetic indices, Mayaud 1980
- A guide to geomagnetic indices derived from Earth surface data, Menvielle et al, 2008



## The K index estimates a disturbance

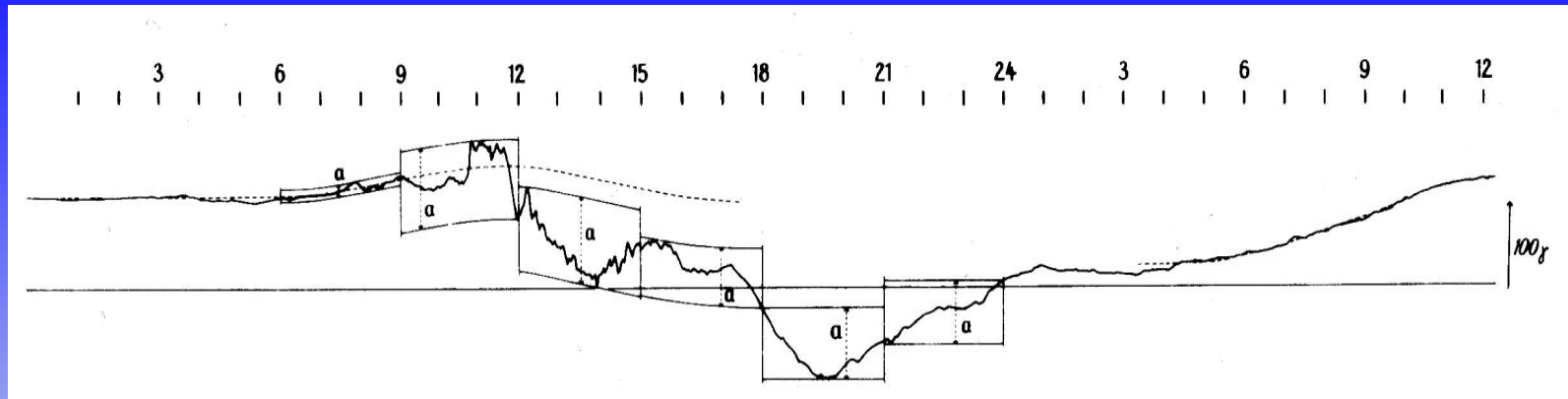

$S_R \# S_q$

Figure from Mayaud, 1980

*“An individual K index is an integer in the range 0 to 9 corresponding to a class that contains the largest range of geomagnetic disturbances in the two horizontal components during a 3-hour UT interval. The limits of these classes at a particular observatory are defined with the intent of producing a geomagnetic disturbance characterisation that does not depend significantly on the location of a sub-auroral, mid- or low- latitude observatory. K indices are assigned to successive 3-hour UT intervals (0-3 hr, 3-6 hr, ..., 21-24 hr UT) giving eight K indices per UT day. K indices can be hand-scaled from magnetograms by an experienced observer, or computer derived using one of the four algorithms that are acknowledged by IAGA. (Menvielle et al., 2008)”*

- K index weak => magnetic quiet day  
 **$S_R$  dominates / radiation**
- K index large => magnetic disturbed day  
**Disturbance dominates / solar wind**

**Magnetic indices based on index K**

- Kp      Ap
- Km      Am
- Aa

## **FIRST USE OF MAGNETIC INDICES**

### **TO SELECT MAGNETIC QUIET DAYS**

**= > physical processes related to solar radiations are  
dominant**

**except for quiet days after big storms  
ionospheric disturbance dynamo**

# Stations used for the Kp (ap) and Km(am)

magnetic activity

$am < 20nT \Rightarrow$  quiet day ;  $am < 13 nT \Rightarrow$  very quiet day

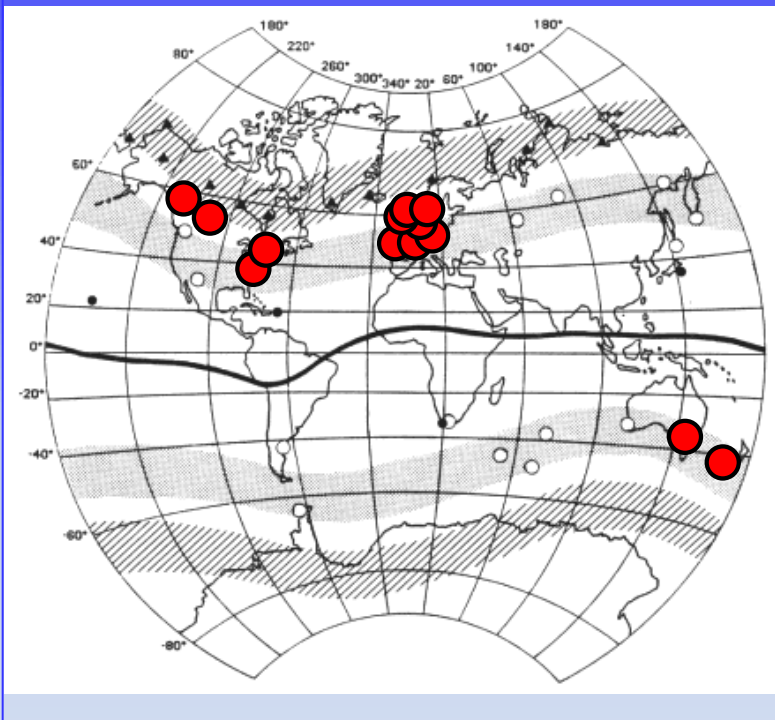

12 observatories  
9 in the northern hemisphere  
2 in the southern hemisphere

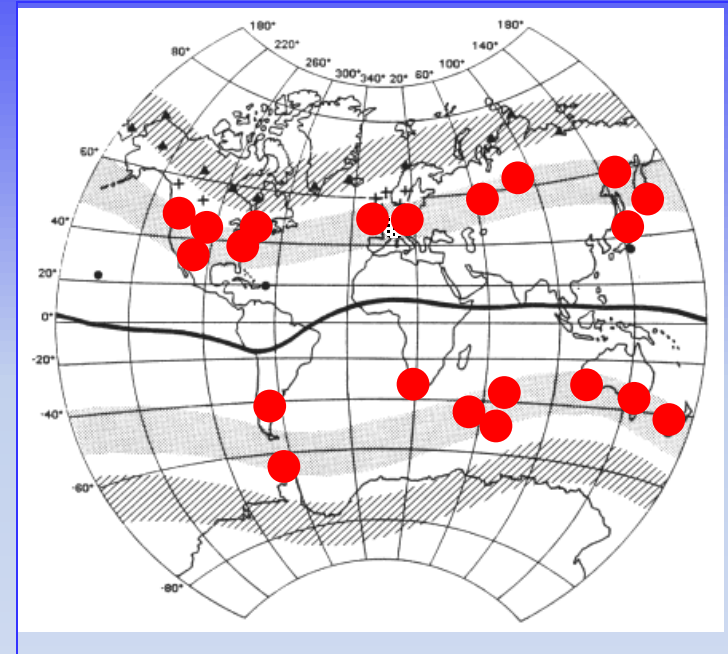

23 observatories  
12 in the northern hemisphere  
9 in the southern hemisphere  
 $K_N$  and  $K_S$

# Daily am < 20 nT

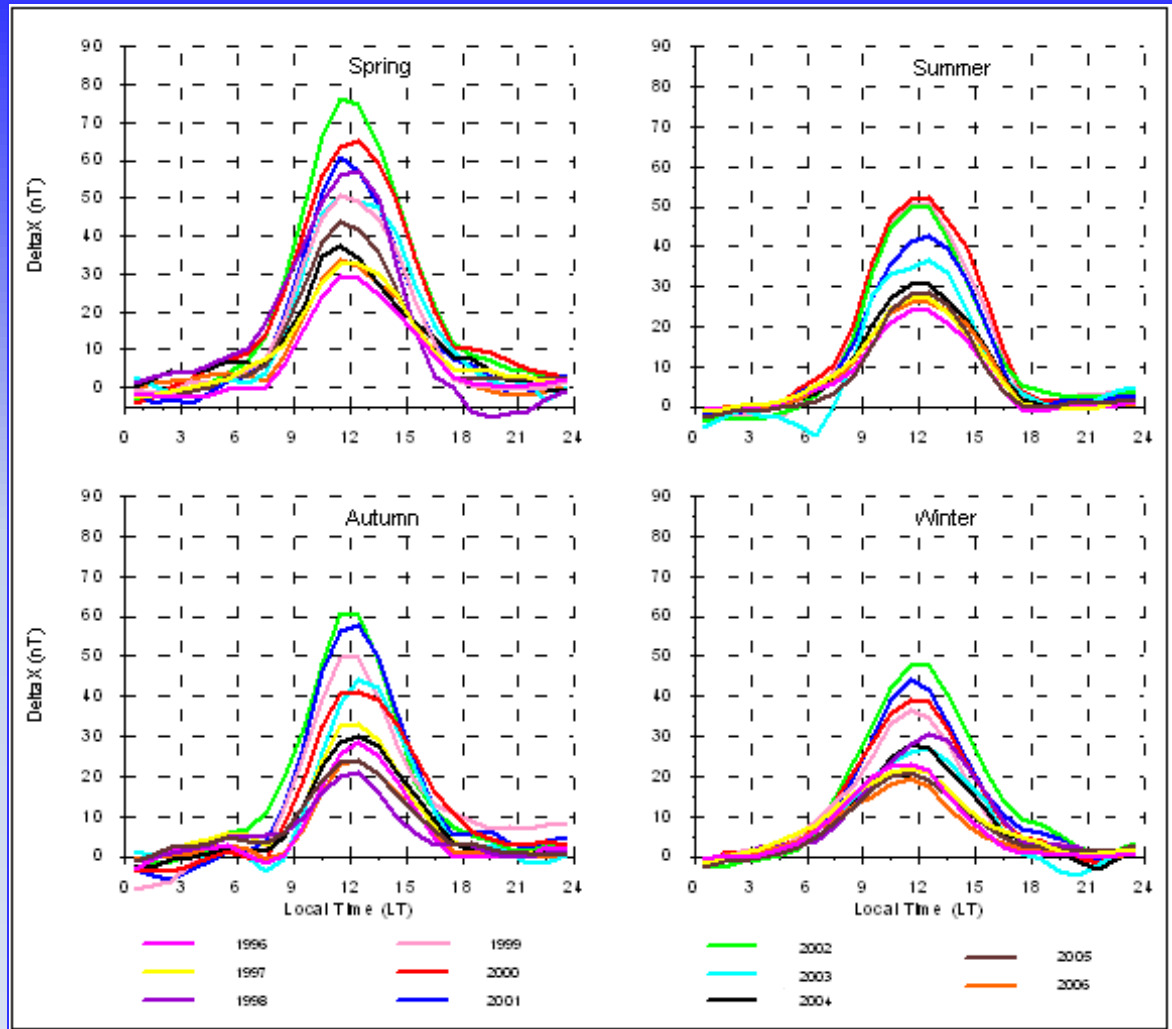
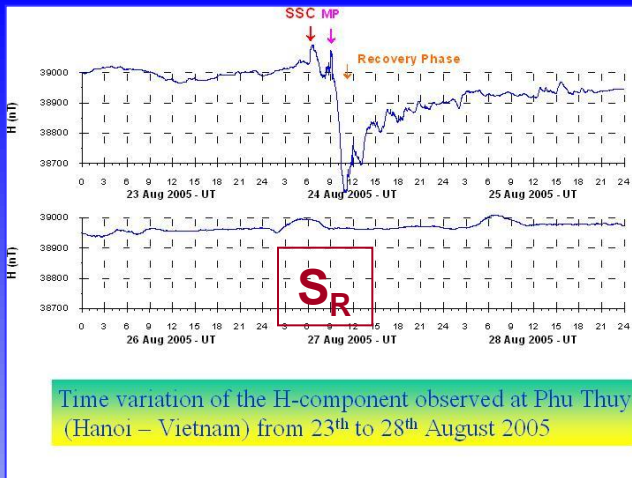

Study on the regular ionospheric dynamo at the origin of the  $Sq/ S_R$

The selection of days is essential for all Studies in **GEOPHYSICS**

Pham Thi Thu et al., 2011  
Annales geophysicae

H component observed at Phu Thuy/Vietnam  
Solar cycle variations

Kp (ap) /Km (am)/aa

## **SECOND USE OF MAGNETIC INDICES**

**TO APPROACH SOLAR WIND  
COMPONENTS (B, V)  
for example**



## Use of magnetic index as proxy of solar wind parameters

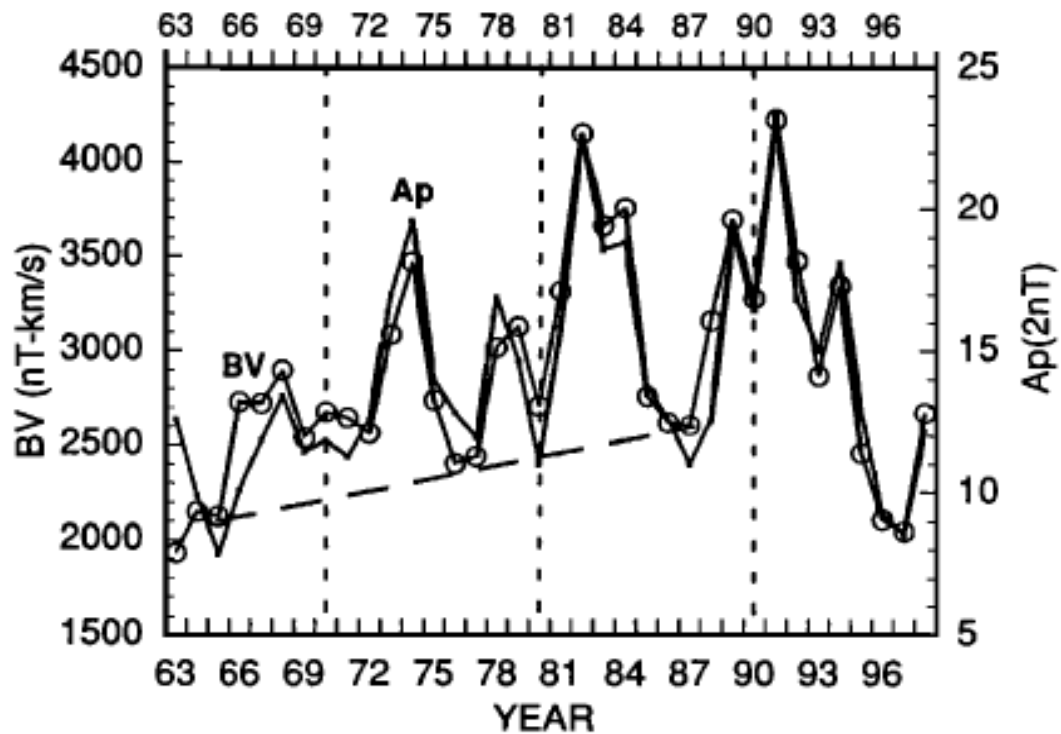

**Figure 4.** Annual mean values of  $A_p$  and the product  $BV$  are plotted for the period 1963 to 1998. Vertical dashed lines represent the solar polar field reversal epochs. The long-term trend in the  $BV$  data is highlighted by the dashed line.

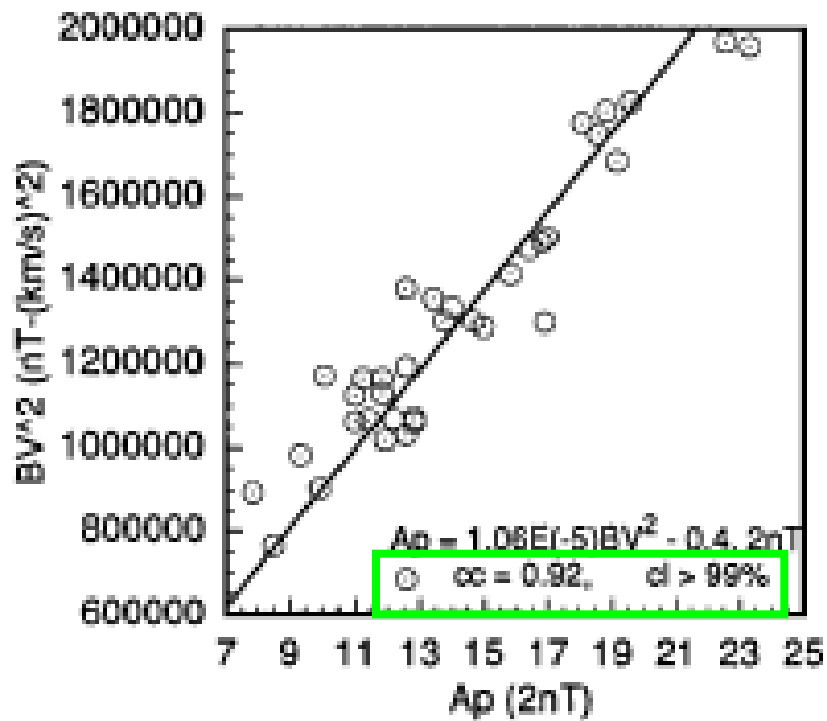

Figure 3. Linear correlation between  $BV^2$  and  $A_p$  data is depicted for the 1963 to 1998 period. It represents the best fit between  $A_p$  and interplanetary parameters ( $V$ ,  $B$ ).

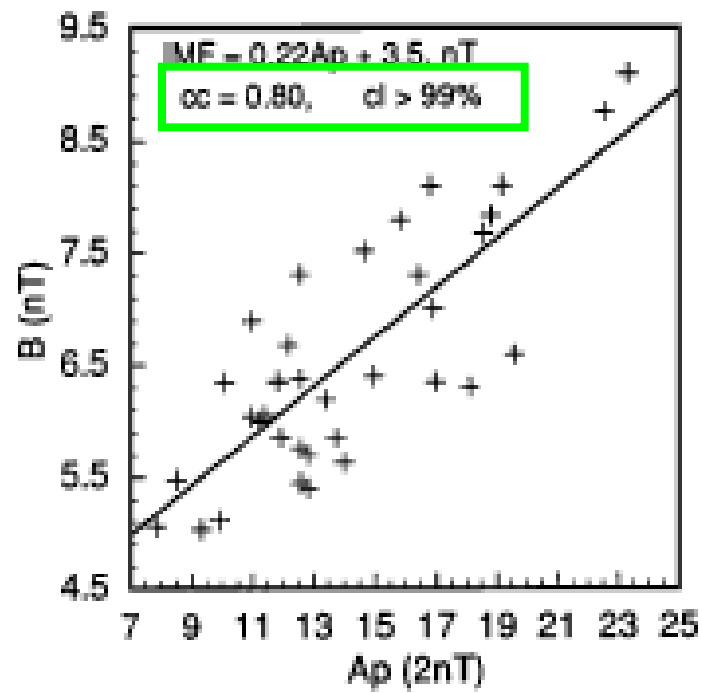

Figure 2. Linear correlation between  $B$  and  $A_p$  annual mean values is shown for the 1963 to 1998 period.

**Kp (ap)/Km (am)/aa**

## **THIRD USE OF MAGNETIC INDICES**

**to study**

- SOLAR ACTIVITY and GEOMAGNETISM**
- LONG TERM VARIATION OF THE SUN**

Solar activity

aa index

First Maximum  
CME

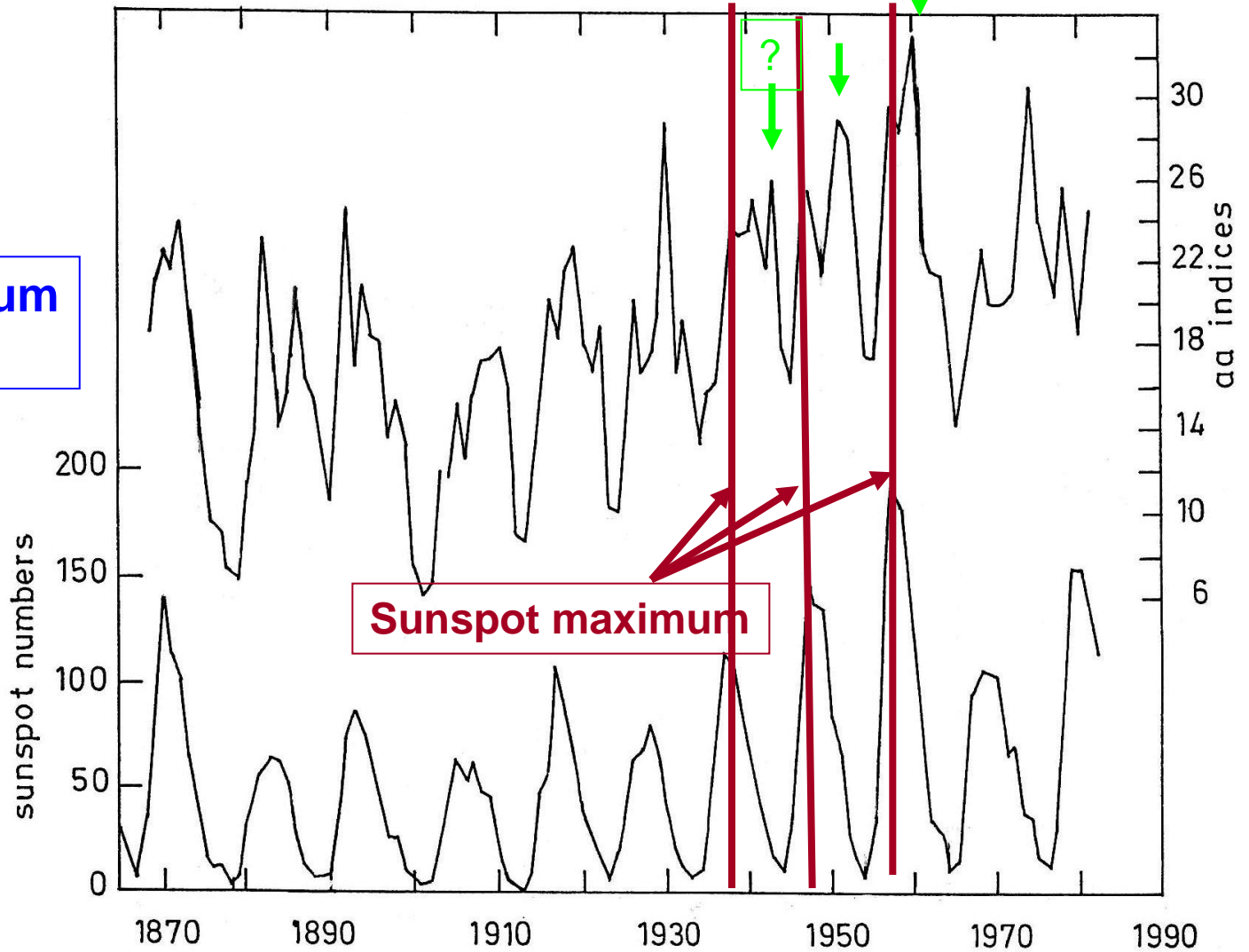

Used for many studies in medicine, climate change, solar wind parameters etc

aa index

Second  
Maximum

Coronal holes

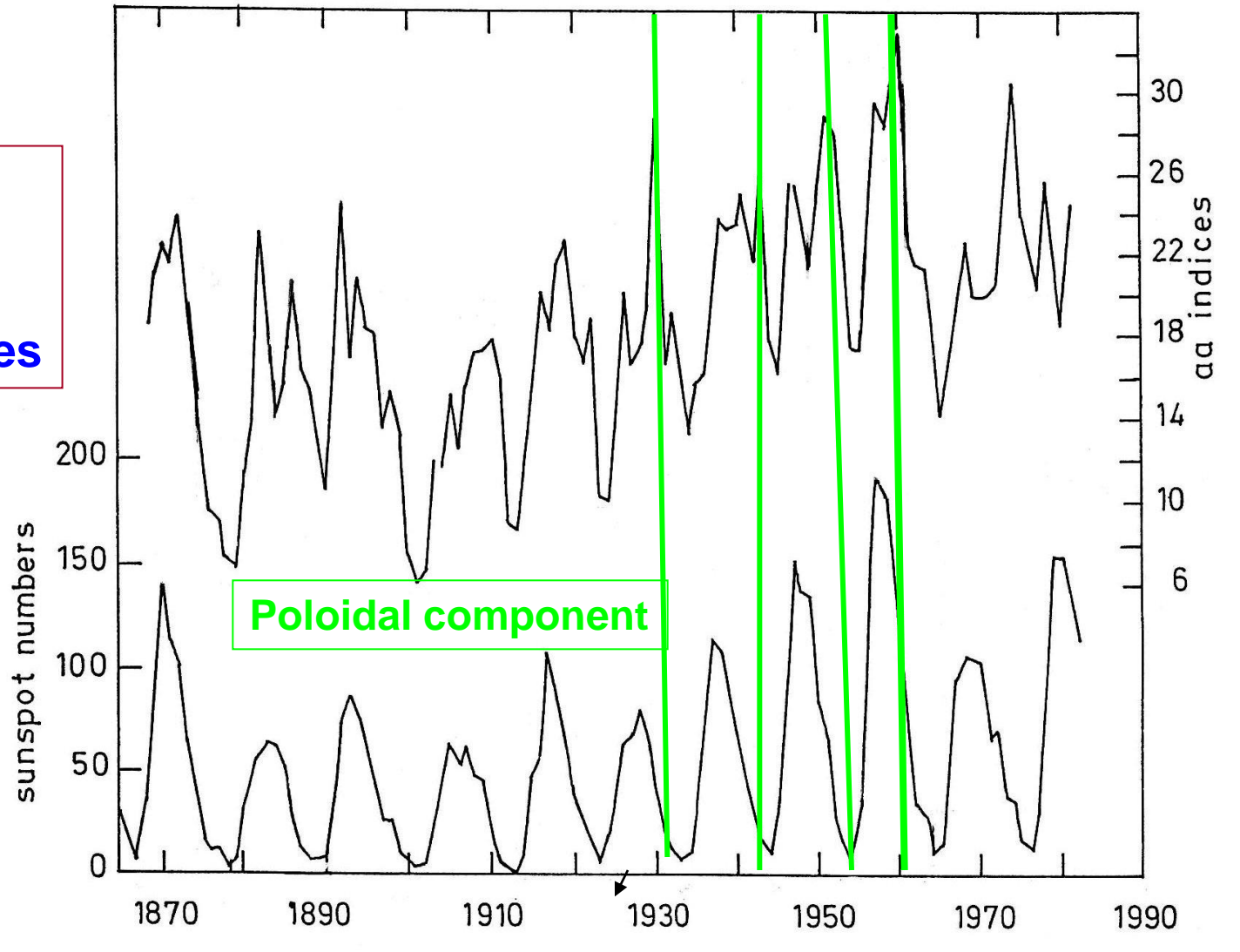

Used for many studies in medicine, climate change, solar wind parameters etc

## **FOURTH USE OF MAGNETIC INDICES**

**to study magnetic storms**



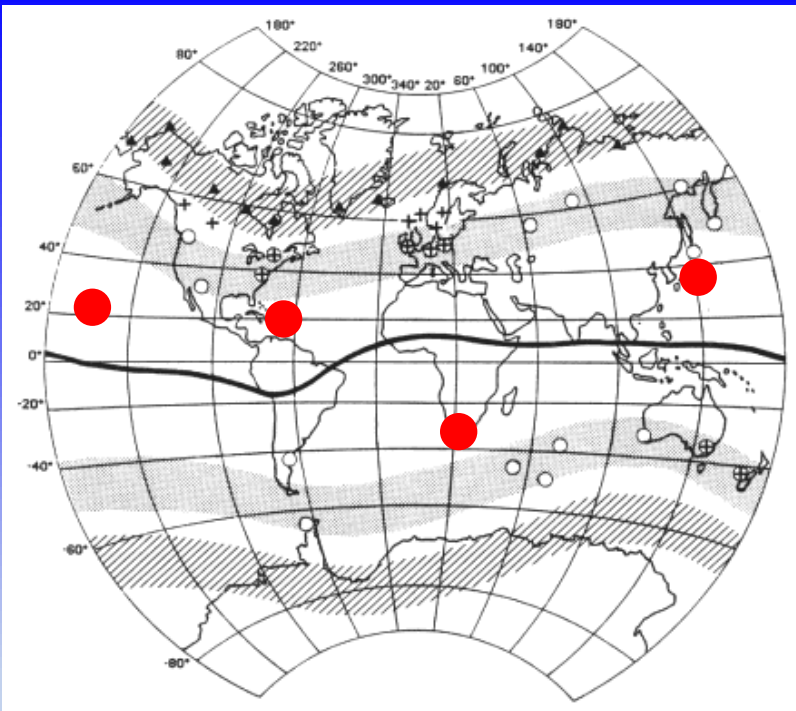

## Dst index symmetric part of the ring current

“Dst is computed using 1-minute values from four low latitude observatories. The locations of which are sufficiently distant from *the auroral and equatorial electrojets* to inhibit noise from these two sources. Local Dst values are computed at each “Dst” observatory at one instant in time. Contributions to  $H$  from the background field (non-transient field of core and crustal origin) *and the solar regular daily variation  $S_R$*  are first subtracted from the observed value of  $H$ . The local Dst value is deduced from the so-obtained residual  $D$  through normalization to the dipole equator. For each 1-hour UT interval, the Dst index is the average of the local Dst hourly mean values at the four “Dst” observatories.” (Menvielle et al., 2008).

# Partial ring current

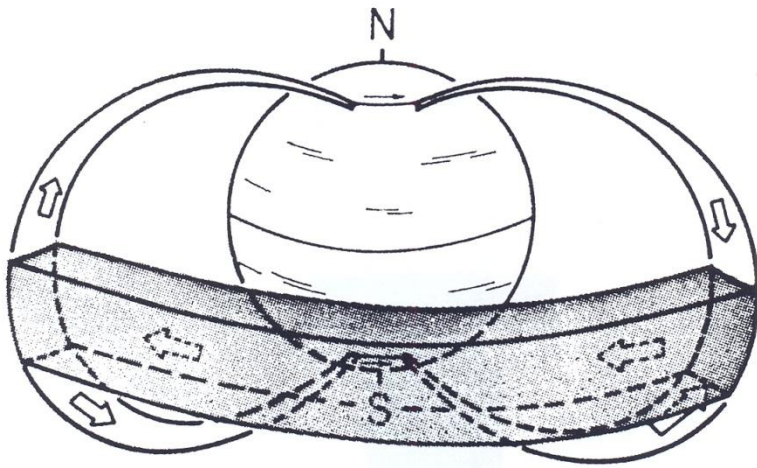

Cummings, JGR, 1966

Fukushima and Kamide, 1973

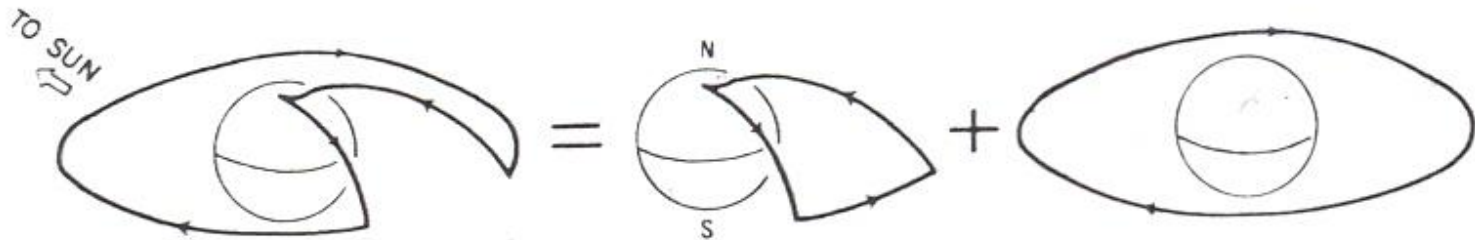

● **SYM + ASY**

● **Dst**

New indices SYM and ASY  
SYM (1')  $\leftrightarrow$  Dst (1h)

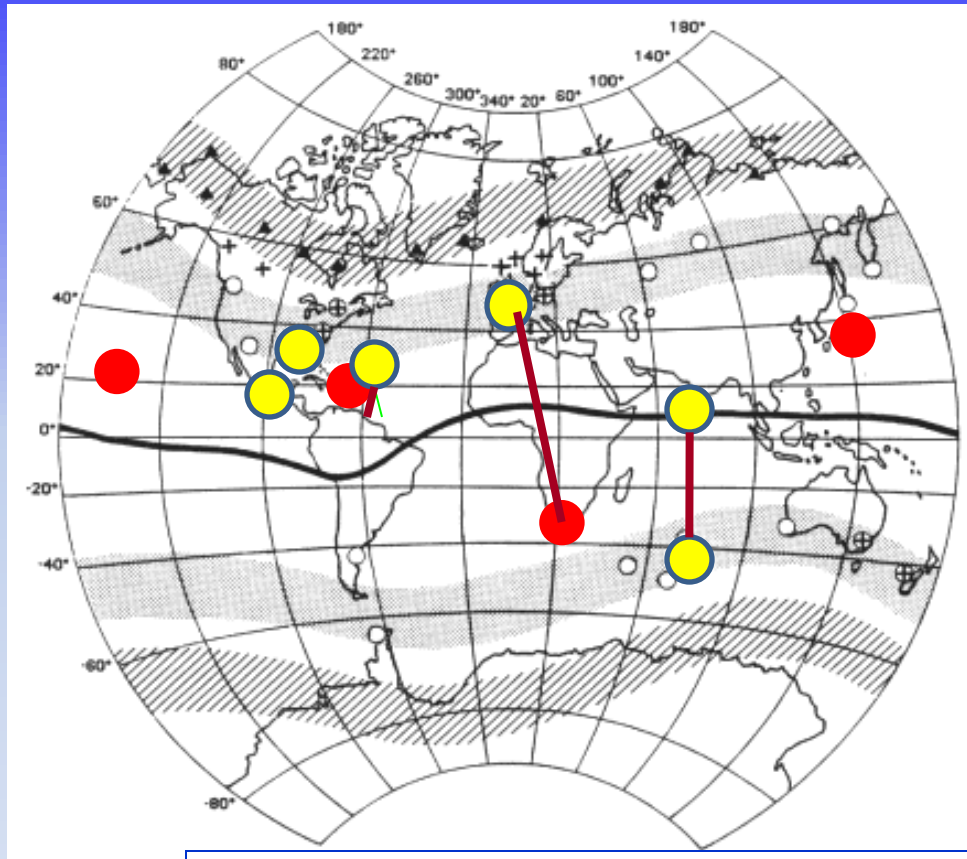

**SYM ~ Dst**

**ASY**

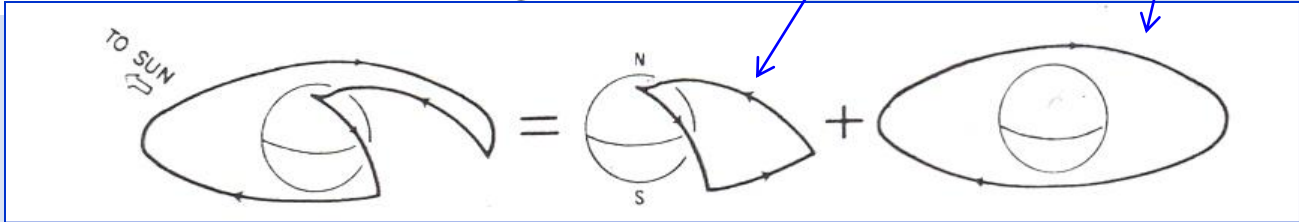



# AU, AL auroral electrojets

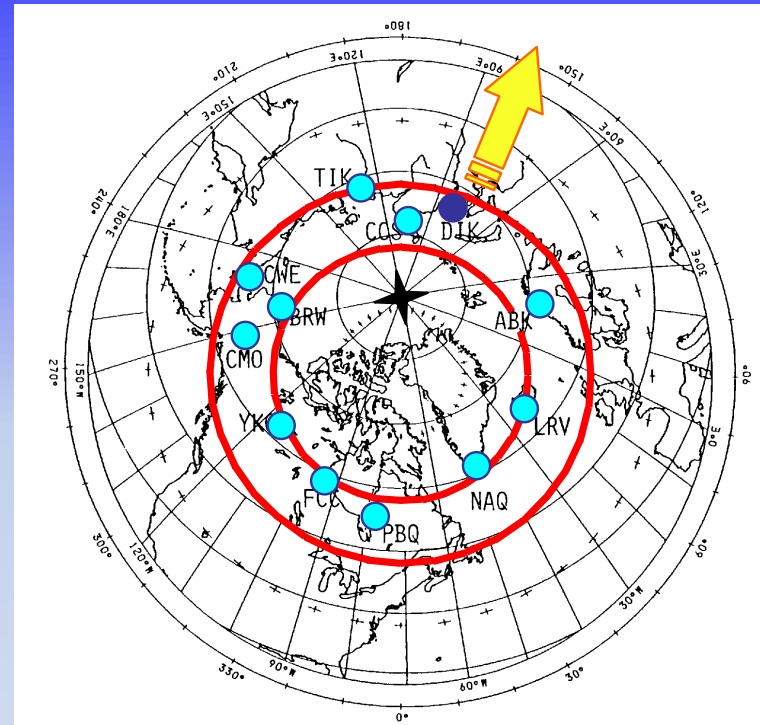
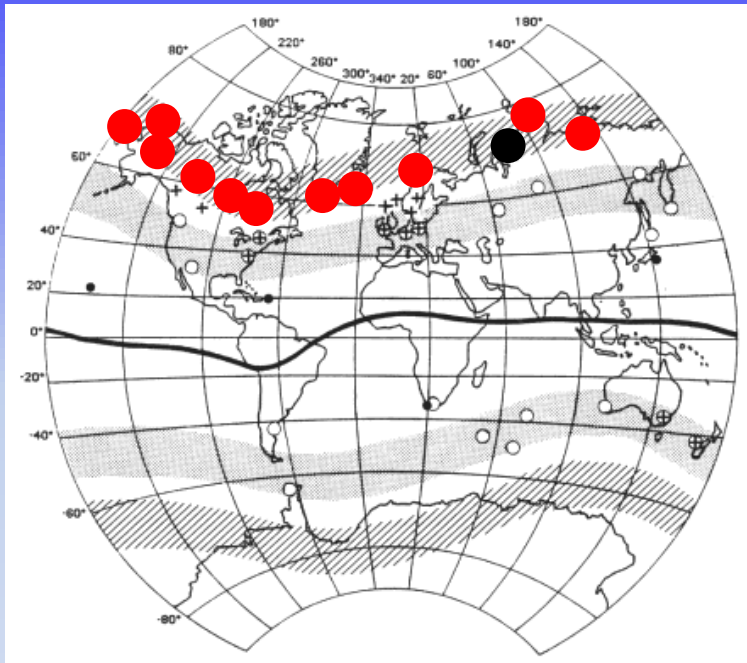

*“The H magnetograms from the “AE” stations are superimposed: the upper envelope defines the AU index, and the lower envelope defines the AL index;  $AE = (AU+AL) / 2$  and  $A0 = (AU-AL) / 2$ . From 2005 onwards, the AE indices are calculated from data from up to 12 sites in the northern auroral zone. AE is expressed in units of nT” (Menvielle et al., 2008)*

- **Magnetic indices are**
  - **Continuously computed**
  - **Available on the web**
  - **Essential to**
    - **Classify days**
    - **To define the geophysical context**
    - **To approach physical parameters**
    - **etc....**

**TRANS DISCIPLINARY TOOLS**



## 4 DYNAMOS IN

### SUN

poloidal /toroidal

### MAGNETOSPHERE

Solar wind

IMF

### IONOSPHERE

Earth's magnetic field

Neutral wind

### EARTH

Motions of the core

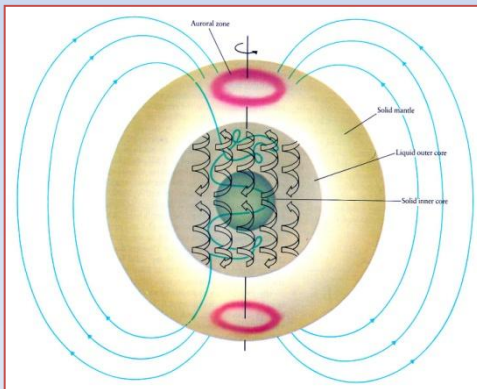

## CURRENT SYSTEMS

### MAGNETOSPHERE

Chapman Ferraro

Ring current

Tail current

### FIELD ALIGNED

### IONOSPHERE

Auroral electrojets

Midlatitude currents

Equatorial electrojet

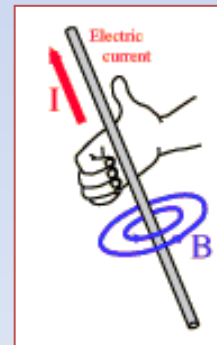

## EARTH'S MAGNETIC FIELD -> Transient variations

Indices -> disturbances

Dst

Aa, Kp, Ap

Km, Am

AU, AL

Equivalent currents

DP1, DP2

Ddyn

$S_R <S_q>, S_q^P$

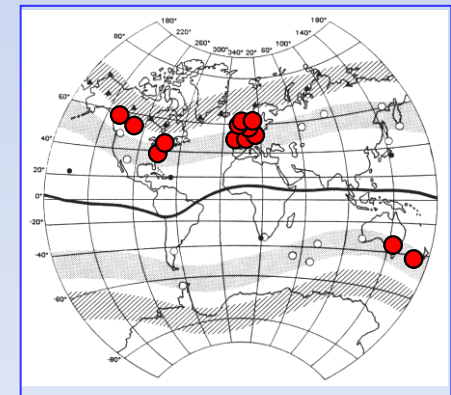

# **Geophysical studies : the initial work all the data are available on the web**

- **Sun**
  - **Sunspot cycle, poloidal cycle**
  - **Solar event**
- **Solar wind parameters V,B (E)**
  - **Solar wind magnetosphere dynamo**
- **AU and AL**
  - **Auroral electrojets**
- **Dst -> [Hsym and H asym]**
  - **Ring current**
- **Intermagnet magnetograms free**
  - **Planetary map of the transient variations of the Earth magnetic field**

**DATA BASE AVAILABLE  
ON THE WEB**

**INTERMAGNET**  
Since year 1991  
CD-ROM

<http://www.intermagnet.bgs.ac.uk>

**AFRICA : 11 permanent observatories**

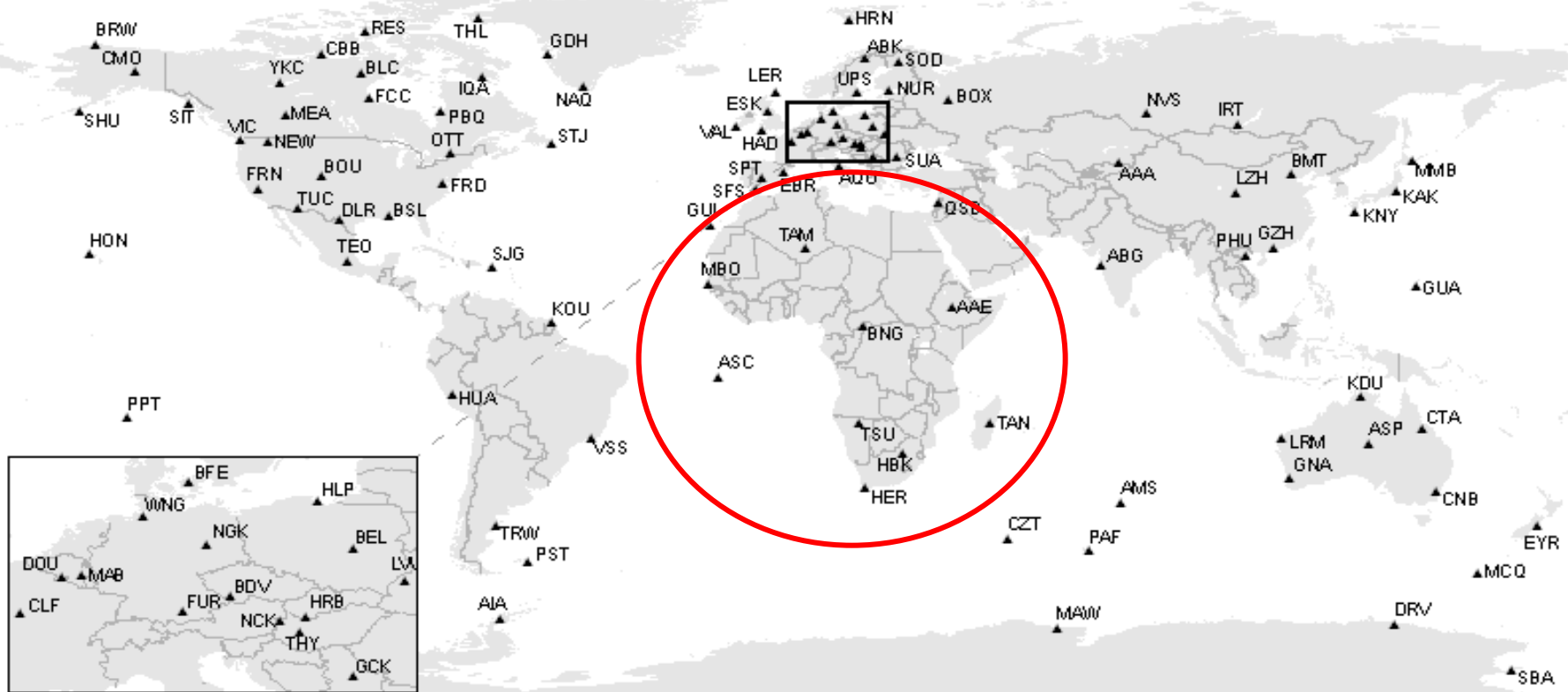

The data consist of one-minute, hourly and daily mean values for the vector  
Component X,Y,Z or D,H,Z  
The intermagnet CD-ROM/DVDs are available at no charge for academic purposes

- Data bases on the web - FREE

All kind of data

<http://spidr.ngdc.noaa.gov/spidr/index.jsp>

Magnetic field data (magnetometer)

<http://www.intermagnet.bgs.ac.uk>

<http://www2.bc.edu/~Kassie/AMBER.html>

<http://ganymede.ipgp.jussieu.fr/jussieu>

Magnetic model

[http://www.iugg.org/IAGA/iaga\\_pages/pubs\\_prods/igrf.htm](http://www.iugg.org/IAGA/iaga_pages/pubs_prods/igrf.htm)

Ionospheric data ionosondes

<http://www.ukssdc.ak.uk>

Solar data

<http://solarscience.msf.nasa.gov/dynamo.shtml>

**SOHO : Solar Heliospheric Observatory under google**

# MAGNETIC INDICES

<http://isgi.cetp.ipsl.fr>

- WDC-C2 for Geomagnetism (Dst, Ae; Kyoto, Japan): <http://swdcwww.kugi.kyoto-u.ac.jp/>
- GFZ (Kp, Ap; Potsdam, Germany): [http://www.gfz-potsdam.de/pb2/pb23/GeoMag/niemegk/kp\\_index/](http://www.gfz-potsdam.de/pb2/pb23/GeoMag/niemegk/kp_index/)
- Observatori de l' Ebre (rapid variations; Roquetes, Spain): <http://www.obsebre.es>
- the Danish Meteorological Institute (PC; Copenhagen, Denmark) <http://web.dmi.dk/fsweb/projects/wdcc1/pcn/pcn.html>
- the Arctic and Antarctic Research Institute (PC; St. Petersburg, Russia) <http://www.aari.nw.ru/>

# GPS networks / On the web for all

## IGS

<http://sopac.ucsd.edu>

<http://cddis.gsfc.nasa.gov> or <http://igs.ensg.ign.fr>

## NOAA et UNAVCO

<http://www.ngs.noaa.gov/CORS>

<http://www.unvaco.org>

## AMMA in IGS now

<http://www.amma-international.org>